

Congratulations !

The **hydroCHEM** is a high quality, precision Conductivity and pH controller and is designed for maximum reliability to give you many years of reliable service.

Despite its impressive list of features, the **hydroCHEM** is a breeze to operate. This manual has been designed to help you get started, and also contains some handy application tips. If at any stage you require assistance, please contact either your local TPS representative or the TPS factory in Brisbane.

The manual is divided into the following sections:

1. Table of Contents

Each major section of the handbook is clearly listed. Sub-sections have also been included to enable you to find the information you need at a glance.

2. Introduction

The introduction has a diagram and explanation of the display and controls of the **hydroCHEM**. It also contains a full listing of all of the items that you should have received with the unit. Please take the time to read this section, as it explains some of items that are mentioned in subsequent sections.

3. Main Section

The main section of the handbook provides complete details of the **hydroCHEM**, including operating modes, calibration, troubleshooting, specifications, and warranty terms.

4. Appendices

Appendices containing background information and application notes are provided at the back of this manual.

TPS Pty Ltd
4 Jamberoo Street
Springwood, Brisbane,
Australia, 4127

Phone : (07) 32 900 400
International : 61 7 32 900 400

Fax : (07) 3808 4871
International : 61 7 3808 4871

E-mail : tps@tpssite.com.au

Web Site : www.tpssite.com.au

<p>hydroCHEM Conductivity and pH Controller</p>
--

<p>Date : 02-Aug-1999 Author : MS Version : 1.0</p>

Contents

1. Introduction	3
1.1 hydroCHEM Display and Controls.....	3
1.2 hydroCHEM Connectors.....	3
1.3 Menu Key	4
1.4 Function Keys	4
1.5 Enter Key	4
1.6 Help Key	4
1.7 Shift Key	4
1.8 Arrow Keys	4
1.9 80 Character Display	4
1.10 Unpacking Information.....	5
1.11 hydroCHEM Menu Structure	6
2. Limits Set-up	7
2.1 Setting the Control Limits.....	7
2.2 Control Direction.....	7
2.3 Control Sensitivity.....	8
2.4 Control Limit Set-up examples	9
3. Control Set-up	10
3.1 Setting up the Conductivity control function	10
3.2 Setting up the pH control function	11
3.3 Selecting Automatic Control or Standby Modes.....	11
4. Quick-Dose Function	12
5. NoFlo Indication	13
5.1 NoFlo Indication Troubleshooting	13
6. Temperature Calibration.....	14
6.1 Temperature Calibration Procedure.....	14
6.2 Temperature Calibration Notes	14
6.3 Temperature Calibration Messages	14
7. Conductivity Calibration.....	15
7.1 Conductivity Calibration Procedure	15
7.2 Conductivity Calibration Notes.....	16
7.3 Conductivity Calibration Messages.....	16
8. TDS Calibration	17
8.1 TDS Calibration Procedure.....	17
8.2 TDS Calibration Notes	18
8.3 TDS Calibration Messages.....	18
9. pH Calibration	19
9.1 pH Calibration Procedure	19
9.2 pH Calibration Notes	20
9.3 pH Calibration Messages	21
10. Setting up the Sample Chamber	22
10.1 Connecting the tubing.....	22
10.2 Adjusting the Flow Rate	23
11. Peristaltic Pumps	24
11.1 Lubricating the Pump Tubing	24
11.2 Priming the Pumps	24
11.3 Pump Maintenance	24
11.4 Replacing the Pump Tubing.....	25
11.5 Tube Saver Feature.....	25

12. Password Security	26
12.1 Enabling the Password Security function.	26
12.2 Using the Password Security function	26
12.3 Changing the Password.....	27
12.4 Disabling the Password Security function	27
13. Good Laboratory Practices (GLP)	28
13.1 Recalling Calibration information on the display.....	28
13.2 Printing Calibration information to the RS232 Port.....	29
13.3 Recalling System information on the display.....	29
13.4 Printing System information to the RS232 Port.....	31
13.5 Failed Calibration	32
13.6 Instrument Serial Number.....	32
13.7 Additional GLP Features	32
14. Datalogging Function	33
14.1 Recording readings manually.....	33
14.2 Recording readings automatically	33
14.3 Recalling Readings from the Notepad.....	34
14.4 Erasing Records from the Notepad.....	35
14.5 Printing Records from the Notepad to the RS232 Port.....	35
15. RS232 Port	36
15.1 Setting the Baud Rate	36
15.2 Sending Readings to the RS232 Port.....	36
15.3 RS232 Configuration.....	36
15.4 Communication and Statistical Software.....	36
15.5 Commands	37
15.6 Data Format	38
15.7 GLP Data Format	39
16. Setting the Clock	40
17. Selecting the Conductivity/TDS units	41
18. Selecting Display Resolution	41
19. Emergency ShutOFF timer	42
19.1 Procedure in event of ShutOFF timer being tripped.....	42
20. Selecting Buffers for Auto Buffer Recognition	43
21. Resetting the hydroCHEM	44
21.1 Resetting the Calibration information only.....	44
21.2 Resetting the Full System information	44
21.3 Factory Default System Settings	45
22. Instrument firmware version number	45
23. Troubleshooting	46
23.1 General Errors.....	46
23.2 Conductivity / TDS Troubleshooting	47
23.3 pH Troubleshooting.....	48
23.4 Temperature Troubleshooting	48
24. Appendices	49
24.1 Mounting the hydroCHEM	49
24.2 Care and Cleaning of Conductivity Sensors	49
24.3 pH Electrode Fundamentals	50
24.4 hydroCHEM Specifications	52
25. Warranty	54

1. Introduction

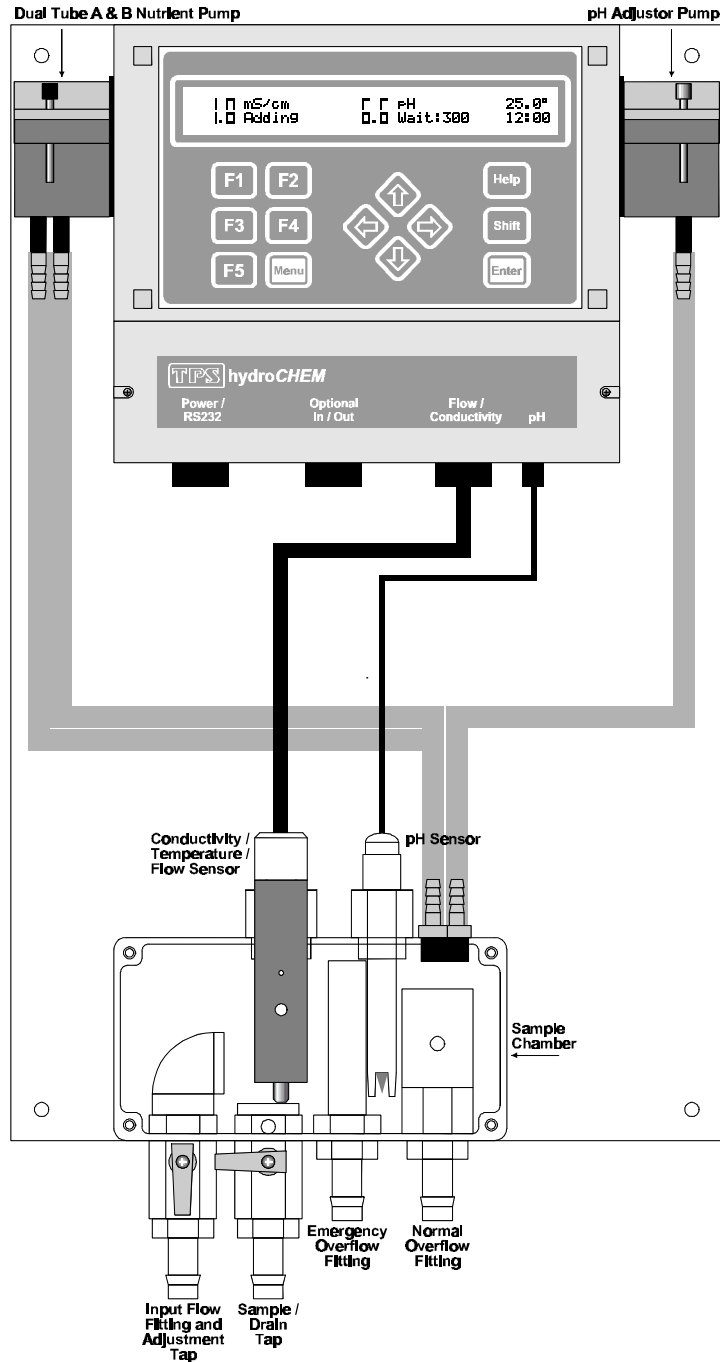

1.1 hydroCHEM Display and Controls



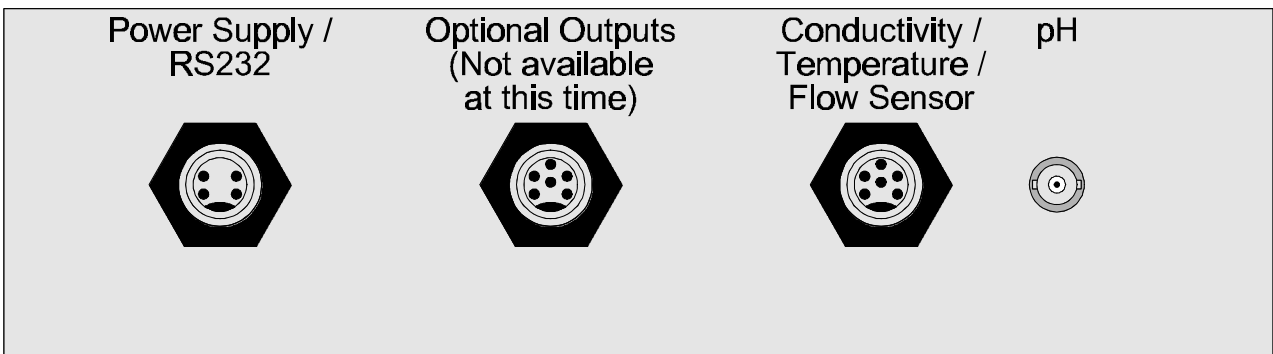





1.2 hydroCHEM Connectors



1.3 Menu Key

- Press the  key to access the user-friendly menu system.
- Press the  key to quit without saving changes when entering data.

1.4 Function Keys

- Press the  to  function keys to select desired options within the menu system.
- These keys perform the following function directly in normal display mode...
 -  : Press to record readings into the Notepad, when Plus-Pack is fitted. See section 14.
 -  : Press to transmit current reading plus date and time to the RS232 port, when Plus-Pack is fitted. See section 15.2.
- Press the  to  to enter a password when the security function is enabled. See section 12.





1.5 Enter Key

Press the  key to accept default values or save changes when entering data.





1.6 Help Key

Press the  key to obtain context-sensitive help messages.

1.7 Shift Key

- Press the  key to alternate between standard display and large digit display. See section 1.9.
- Press and hold the  key while scrolling data with the  and  keys to speed up the scrolling rate.

1.8 Arrow Keys

- Press the  and  keys to scroll values up and down when entering or displaying data.
- Press the  and  keys to move the cursor left and right when setting the calendar clock, when Plus-Pack is fitted. See section 16.

1.9 80 Character Display

- 80 character alphanumeric display with user-friendly menu and context-sensitive help system.
- Standard display mode shows Conductivity and pH data, limits and control status. Temperature data is also displayed. The current time is displayed when Plus-Pack is fitted. For example...

1. 8mS/cm (2. 0)	6. 6pH (6. 5)	22. 0°C
Addi ng	Wai t: 300	12: 00

- Large digit mode shows Conductivity and pH in double height digits. Control status and Temperature data are displayed in standard digits. The current time is displayed in standard digits when Plus-Pack is fitted. For example...

1. 8 mS/cm	6. 6 pH	25. 0°
1. 0 Addi ng	0. 0 Wait: 300	12: 00

1.10 Unpacking Information

Before using your new **hydroCHEM**, please check that the following accessories have been included:

	Part No
<i>Standard hydroCHEM Kit...</i>	
1. hydroCHEM Hydroponics Controller	111103
2. 4 Terminal Conductivity Sensor, 5m cable	122215
3. Gel-filled Submersible pH Sensor, 5m cable	111224
4. pH4.00 Buffer, 200mL	121381
5. pH6.88 Buffer, 200mL	121306
6. 2.76mS/cm Conductivity Standard, 200mL	122306
7. Plug-Pack Power Supply	130048
8. hydroCHEM Handbook	130050

hydroCHEM-P Kit...

1. hydroCHEM-P Hydroponics Controller.....	111105
with in-built peristaltic dosing pumps	
2. 4 Terminal Conductivity Sensor, 5m cable	122215
3. Gel-filled Submersible pH Sensor, 5m cable	111224
4. pH4.00 Buffer, 200mL	121381
5. pH6.88 Buffer, 200mL	121306
6. 2.76mS/cm Conductivity Standard, 200mL	122306
7. Plug-Pack Power Supply	130048
8. 10 metres of 6mm Clear Tubing	NPH.25
9. 3 x non-return valves for input side of pumps.....	NNBR
10. Syringe of Lubricant for Peristaltic Pump Tubing...	130103
11. hydroCHEM Handbook	130050

hydroCHEM-DS Kit...

1. hydroCHEM-DS Hydroponics Controller	111109
with in-built peristaltic dosing pumps, sample chamber and mounting panel	
2. 4 Terminal Conductivity Sensor, 0.5m cable	122205
3. Gel-filled pH Sensor, 0.5m cable.....	121227
4. pH4.00 Buffer, 200mL	121381
5. pH6.88 Buffer, 200mL	121306
6. 2.76mS/cm Conductivity Standard, 200mL	122306
7. Plug-Pack Power Supply	130048
8. 10 metres of 6mm Clear Tubing	NPH.25
9. 10 metres of 13mm Black Poly Tubing	NPH.5
10. 4 x 13mm Poly Tube Clips.....	NC13
11. 3 x non-return valves for input side of pumps.....	NNBR
12. Syringe of Lubricant for Peristaltic Pump Tubing...	130103
13. hydroCHEM Handbook	130050

Options that may have been ordered with your hydroCHEM...

1. Plus-Pack option (includes RS232 cable)	130100
2. Communication software for Windows 3.1,	130086
95, and NT	

Other spares...

1. RS232 Interface Cable	130041
--------------------------------	--------

1.11 hydroCHEM Menu Structure

A detailed breakdown of the menu system of the **hydroCHEM** is shown below. This diagram provides a quick reference for the menu functions available for the **hydroCHEM**.

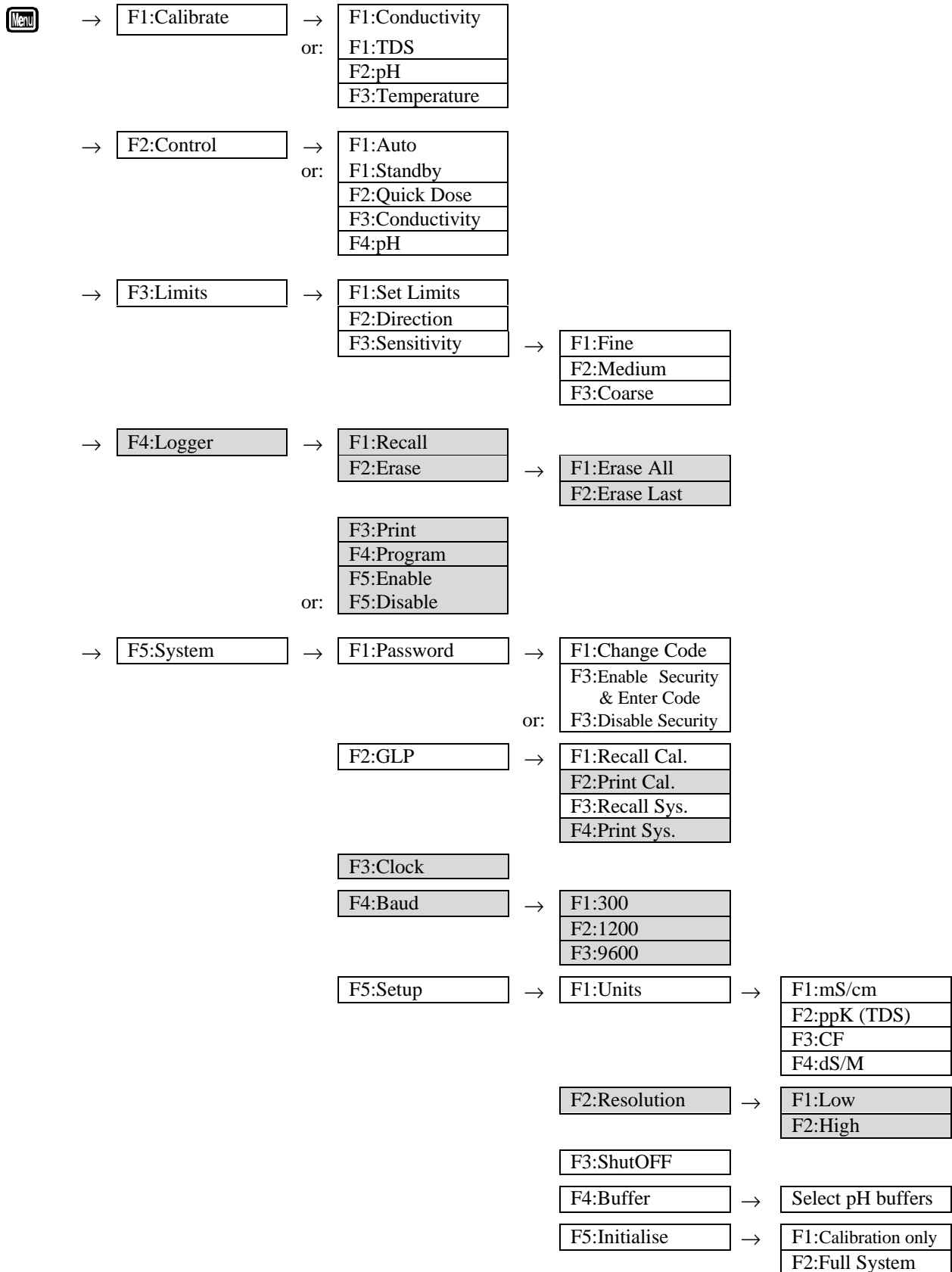

Functions in shaded cells are available when the Plus-Pack option is fitted.





2. Limits Set-up

The limits must be set to the required values before attempting to use the **hydroCHEM** for automatic control.

2.1 Setting the Control Limits

1. Select the Limits menu ( → **F3: Li mi ts**).
2. Select **F1: Set li mi ts** from the menu. The current Conductivity limit is displayed. For example...

Enter Conductivity Limit : 2. 0 mS/cm

Use the  and  keys to set the Conductivity limit. The allowable range is 0.0 to 9.9 mS/cm. Press  to save the new value, or press  to quit without saving the changes.

3. The current pH limit is now displayed. For example...

Enter pH Limit : 6. 5pH

Use the  and  keys to set the pH limit. The allowable range is 0.0 to 14.0 pH. Press  to save the new value, or press  to quit without saving the changes.

4. The control limits are now set to the required values.

2.2 Control Direction

The **hydroCHEM** is factory set to add nutrient when the Conductivity reading is lower than the limit, and to add acid when the pH reading is higher than the limit. To change these settings...

1. Select the Limits menu ( → **F3: Li mi ts**).
2. Select **F2: Di rect i on** from the menu. The following screen will now be displayed...

Select Conductivity Direction
→F1: Add when LOW F2: Add when HIGH

The arrow indicates the current selection.

Press  to add nutrient when the Conductivity reading is lower than the limit.

Press  to add freshwater when the Conductivity reading is higher than the limit.

3. The **hydroCHEM** confirms the selection and then goes on to select the pH Direction...

Select pH Direction
F1: Add when LOW →F2: Add when HIGH

The arrow indicates the current selection.

Press  to add alkali (eg. Soda Ash) when the pH reading is lower than the limit.

Press  to add acid when the pH reading is higher than the limit.

4. The **hydroCHEM** confirms the selection before going back to the Limits menu.

2.3 Control Sensitivity

To stop the pumps being rapidly switched on and off, the **hydroCHEM** operates the pumps for a preset band around the control limit. Examples to illustrate this are given at the end of this section. To select the Control Sensitivity...

1. Select the Limits menu ( → **F3: Li mi ts**).
2. Select **F3: Sensi ti vi ty** from the menu. The following screen will now be displayed...

<p>Select Cond. Sensi ti vi ty F1: Fi ne → F2: Medi um F3: Coarse</p>
--

The arrow indicates the current selection.

Press  to select Fine Sensitivity. The control band will be 0.1 mS/cm.

Press  to select Medium Sensitivity. The control band will be 0.2 mS/cm.

Press  to select Coarse Sensitivity. The control band will be 0.3 mS/cm.

3. The **hydroCHEM** confirms the selection and then goes on to select the pH Sensitivity...

<p>Select pH Sensi ti vi ty F1: Fi ne → F2: Medi um F3: Coarse</p>

The arrow indicates the current selection.

Press  to select Fine Sensitivity. The control band will be 0.1 pH.

Press  to select Medium Sensitivity. The control band will be 0.2 pH.

Press  to select Coarse Sensitivity. The control band will be 0.3 pH.

4. The **hydroCHEM** confirms the selection before going back to the Limits menu.

2.4 Control Limit Set-up examples

- The following diagram illustrates the Conductivity control action of the **hydroCHEM**, when the limit is set to 2.0 mS/cm, adding when low, with medium control sensitivity (0.2 mS/cm).

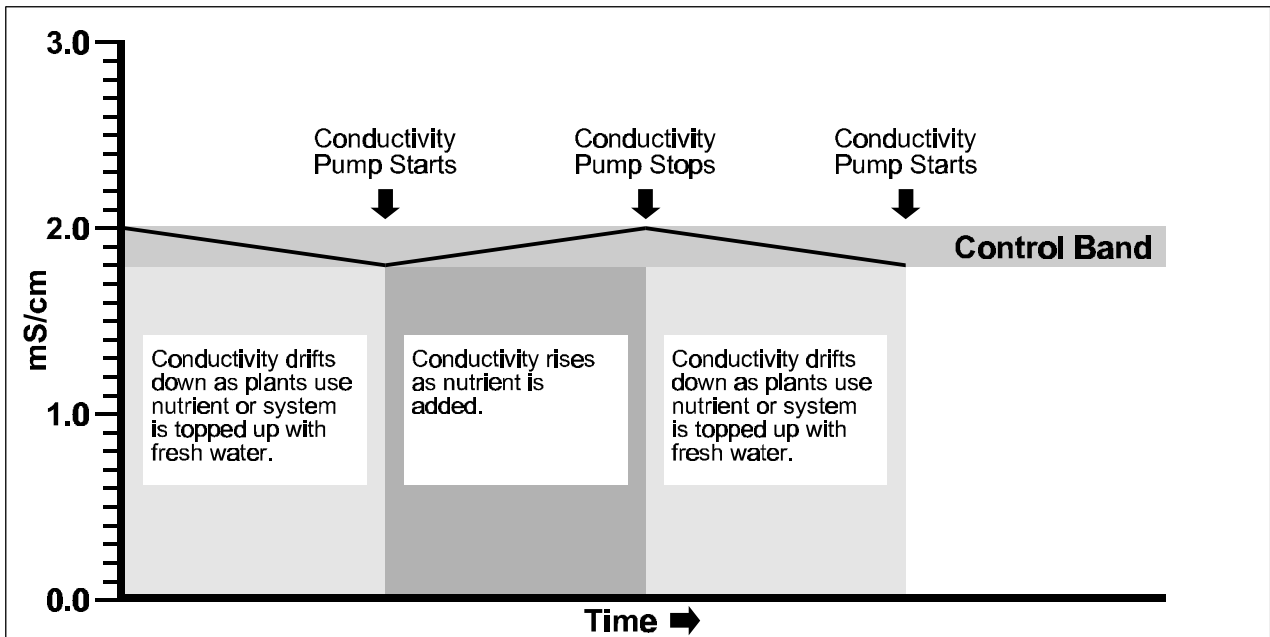

- The following diagram illustrates the pH control action of the **hydroCHEM**, when the limit is set to 6.5 pH, adding when high, with fine control sensitivity (0.1pH).

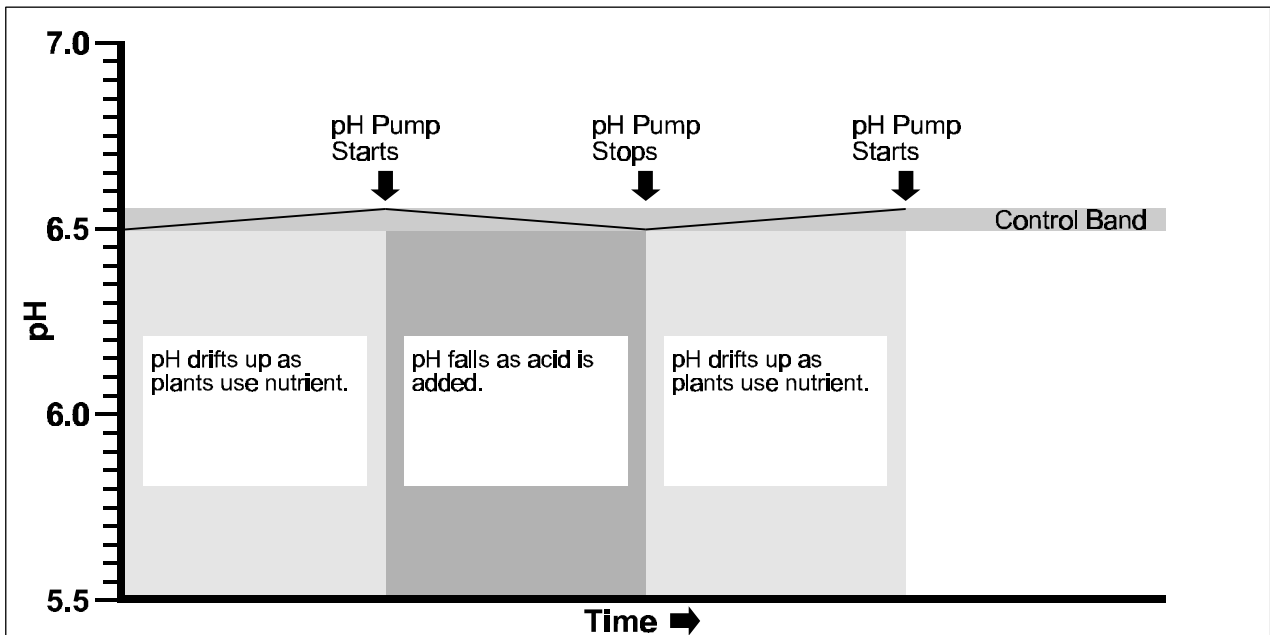

3. Control Set-up

The **hydroCHEM** control function must be set up correctly before attempting to use the **hydroCHEM** for automatic control. Setting up the control function involves setting the ON and OFF times for each pump. Conductivity and pH ON and OFF times can be set independently, to allow for the different effects these have on the total system.

The ON time is the maximum amount of time the pump will operate continuously. For example, if the Conductivity ON time is set to 5 minutes, the Conductivity pump will add A&B Nutrient for a maximum of 5 minutes and then wait for the OFF time. Of course, if the Conductivity gets back within the limit earlier, the pump will stop before the end of the 5 minutes.

The OFF time is the waiting time between ON cycles. Even if the Conductivity or pH go outside their normal limits during the OFF time, the **hydroCHEM** will not activate the relevant pump until the entire OFF time has elapsed.



In the examples shown in sections 3.1 and 3.2, the ON times are both set to 5 minutes and the OFF times are set to 10 minutes. This means that the unit will dose for a maximum of 5 minutes, then wait for 10 minutes. These ON and OFF times cycle repetitively. At all times, the Conductivity and pH pumps will only operate when the readings are outside the limits.

Correct use of an ON and OFF cycle will avoid overdosing problems.

3.1 Setting up the Conductivity control function

1. Select the Control menu ( → F2: Control).
2. Select F3: Conductivity from the menu. The following screen is now displayed...



Enter ON Time : 5 minutes, 0 = Offline

Use the  and  keys to enter the ON time for the Conductivity pump (up to 30 minutes). Enter Zero to take the Conductivity pump off line.

Press  to save the new value, or press  to quit without saving the changes.

3. The **hydroCHEM** then goes on to the OFF time entry...

ON Time : 5 minutes
Enter OFF Time : 10 minutes, 0 = Untimed

Use the  and  keys to enter the OFF time for the Conductivity pump (up to 30 minutes). Enter Zero to make the Conductivity pump operate on demand whenever the reading is outside the limit.



Press  to save the new value, or press  to quit without saving the changes.

4. The Conductivity control function is now set up and the **hydroCHEM** returns to the Control menu.

3.2 Setting up the pH control function

5. Select the Control menu (Menu → F2: Control).
6. Select F4: pH from the menu. The following screen is now displayed...



Enter ON Time : 5 minutes, 0 = Offline

Use the  and  keys to enter the ON time for the pH pump (up to 30 minutes).
Enter Zero to take the pH pump off line.

Press  to save the new value, or press  to quit without saving the changes.

7. The **hydroCHEM** then goes on to the OFF time entry...

ON Time : 5 minutes
Enter OFF Time : 10 minutes, 0 = Untimed

Use the  and  keys enter the OFF time for the pH pump (up to 30 minutes).
Enter Zero to make the pH pump operate on demand whenever the reading is outside the limit.

Press  to save the new value, or press  to quit without saving the changes.

8. The pH control function is now set up and the **hydroCHEM** returns to the Control menu.

3.3 Selecting Automatic Control or Standby Modes

To enable the **hydroCHEM** to automatically control Conductivity and pH, Automatic mode must be selected. The pumps will operate according to the ON and OFF times discussed in sections 3.1 and 3.2, when Conductivity and/or pH readings are outside the limits.

To disable automatic control (eg. when calibrating the unit), Standby mode must be selected.

To switch between Automatic and Standby modes...

1. Select the Control menu (Menu → F2: Control).
2. When the **hydroCHEM** is in Standby mode, select F1: Auto to switch to Automatic mode.
When the **hydroCHEM** is in Automatic mode, select F1: Standby to switch to Standby mode.

NOTE

Automatic control is disabled when there is no flow in the sample chamber. The Conductivity, pH and Temperature data is replaced by "NoFlow" when there is no flow.



4. Quick-Dose Function

The Quick-Dose function enables the operator to quickly add a measured dose of Nutrient and/or pH adjustor, regardless of the Limits or Control set-up. This feature is particularly useful to trim up a fresh tank of water before commencing normal automatic control.

To begin a Quick-Dose cycle...



1. Select the Control menu ( → **F2: Control**).
2. Select **F2: Quick Dose** from the menu.
3. The **hydroCHEM** now prompts you to enter the dosing time for the A & B Nutrient pump. The default time is 5 minutes....

Enter Cond. Quick Dose Time : 5 mi ns

Use the  and  keys to set the time for which the A & B Nutrient pump is to operate (from 0 to 10 minutes).

4. The **hydroCHEM** now prompts you to enter the dosing time for the pH pump. The default time is 5 minutes. The Conductivity pump time remains on the display, for your reference...

Cond. Quick Dose Time : 5 mi ns
Enter pH Quick Dose Time : 5 mi ns

Use the  and  keys to set the time for which the pH pump is to operate (from 0 to 10 minutes).

5. The **hydroCHEM** now returns to the Control menu. To start the Quick-Dose cycle, the unit must be returned to normal display mode. The display will count down the dosing time individually for each pump.

NOTES

- To stop the Quick-Dose cycle, press the  key. It is then necessary to repeat this programming procedure to re-enable the function.
- The Quick-Dose function is enabled even when there is no flow through the sample chamber. Before using this function ensure that addition of nutrient and/or pH adjustor will not over-dose your system.

5. NoFlo Indication

The **hydroCHEM** uses the Conductivity reading to determine if there is an adequate flow of nutrient solution through the sample chamber. See section 10.2 for details on how to adjust the sample flow rate.

This feature has been provided so that the **hydroCHEM** can be switched on at all times, and automatic dosing only occurs when the pump which feeds the sample chamber is operating. No separate flow sensing or timer cycle is therefore needed for the **hydroCHEM** to dose at the required times.

The following conditions occur when there is little or no flow of nutrient through the sample chamber...

- The data is replaced by "NoFl o" on the **hydroCHEM** display.
- Automatic control is disabled. The Nutrient and pH pumps will not operate until adequate flow is restored.
- Quick-Dose is still operational. Ensure that the quick dose cycle will not cause the system to be over-dosed.
- The Conductivity, pH and Temperature being sent to the RS232 port is replaced with spaces (see section 15.6).

5.1 NoFlo Indication Troubleshooting

Symptom	Possible Causes	Suggested Remedy
"NoFl o" message does not appear, even when the Conductivity sensor is dry and in air	<ol style="list-style-type: none"> 1. Sensor has a build-up of salts or algae between wires. 2. Sensor is faulty. 	<p>Clean probe as per section 24.2.2.</p> <p>Return sensor to factory for repair or replacement.</p>
"NoFl o" message appears even when the Conductivity sensor is in solution.	<ol style="list-style-type: none"> 1. Conductivity of solution is below 500 $\mu\text{S}/\text{cm}$ (245 ppm TDS). 2. Sensor is faulty. 	<p>The flow sensing function only operates if the Conductivity is above 500 $\mu\text{S}/\text{cm}$ (245 ppm TDS).</p> <p>An optional pump detector is available to solve this problem. Please contact the factory or your distributor.</p> <p>Return sensor to factory for repair or replacement.</p>

6. Temperature Calibration

The temperature readout must be calibrated or manually set before attempting Conductivity or pH calibration. The decimal point is replaced by a “ * ” if the reading is not calibrated.

6.1 Temperature Calibration Procedure





1. Ensure that the **hydroCHEM** is in Standby mode (see section 3.3).
2. Plug the Conductivity/Temperature sensor into the **Cond/Temp** socket.
3. Place the sensor into a beaker of room temperature water alongside a good quality mercury thermometer. Stir the sensor and the thermometer gently to ensure an even temperature throughout the beaker.
4. Select Temperature Calibration ( → F1: Calibrate → F3: Temperature).

The Temperature Calibration screen is now displayed. For example...

Enter Actual Temperature : 25. <u>0</u>	24*0 ⁰ c
Temperature Calibration	Menu Quits

The cursor is at the new temperature value you will be setting.

The current reading from the Temperature sensor is displayed on the far right of the top line.

5. When the reading from the Temperature sensor has stabilised, use the  and  keys to enter the same temperature as measured by the mercury thermometer.
6. Press the  key to calibrate the temperature readout.
Alternatively, press the  key to abort temperature calibration.

6.2 Temperature Calibration Notes

1. The **hydroCHEM** has an allowable Offset range of -10.0 to $+10.0$ °C. If calibration fails due to the Offset being outside these limits, then please consult the Troubleshooting guide (section 23.4) for possible remedies.
2. Temperature calibration information is retained in memory when the **hydroCHEM** is switched off, even when the power supply is removed. This information can be recalled later using the GLP function (see section 13).
3. Temperature does not need to be re-calibrated unless the Conductivity/Temperature sensor is replaced or the meter is initialised.

6.3 Temperature Calibration Messages

1. If a temperature calibration has been successfully performed, the **hydroCHEM** will display the following message and the offset of the sensor. For example...

Temperature Calibration OK 0. 1 ⁰ C Offset
--

2. If a temperature calibration has failed, the **hydroCHEM** will display the following message and the failed offset value of the sensor. For example...

Temperature Calibration Failed 11. 0 ⁰ C Offset

7. Conductivity Calibration

Before attempting a Conductivity calibration ensure that Temperature has been correctly calibrated (see section 6). A “ * ” in the Temperature readout in place of the decimal point indicates that Temperature is NOT calibrated.

See section 17 for details on how to select the Conductivity readout units that you wish to use.



7.1 Conductivity Calibration Procedure

1. Ensure that the **hydroCHEM** is in Standby mode (see section 3.3).
2. Plug the Conductivity sensor into the **Cond/Temp** socket.
3. Rinse the sensor in distilled water. Shake off as much water as possible. Blot the outside of the sensor dry.

Zero Calibration

4. Let the sensor dry in air.
5. Select Conductivity Calibration ( → **F1: Calibrate** → **F1: Conductivity**).
6. The **hydroCHEM** will recognise the low Conductivity signal and attempt a Zero calibration. For example...

0*1mS/cm	25.0 ⁰ c
Press Enter to Calibrate to Zero	

7. When the reading has stabilised at or near zero, press  to calibrate or  to quit. The "*" will not be removed after a zero calibration.

Standard Calibration

8. Place the Conductivity sensor into a sample of 2.76 S/cm or 1.41 S/cm standard so that it is immersed at least to the first vent hole, as per the diagram below.

DO NOT place the sensor directly into the bottle of standard. Discard the used sample of standard after use.

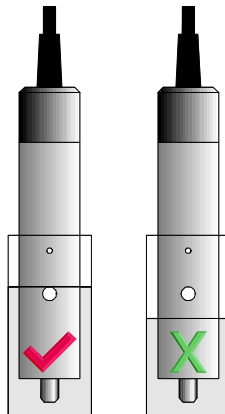

9. Select Conductivity Calibration ( → **F1: Calibrate** → **F1: Conductivity**). The calibration screen will be displayed, with the Conductivity standard to be used. For example...

2*5mS/cm	25.0 ⁰ c
Press Enter to Calibrate to 2.76mS/cm	

10. When the reading has stabilised, press  to calibrate. The "*" will now be replaced by a decimal point if calibration was successful.
11. The **hydroCHEM** is now calibrated for Conductivity and is ready for use in this mode.

7.2 Conductivity Calibration Notes

1. When a Zero calibration fails, span calibration is lost. Both a Zero and a Span calibration **MUST** be done once the problem has been remedied.
2. The allowable zero range for the Conductivity sensor is 0 to 0.2 mS/cm. If a zero calibration fails, please consult the Troubleshooting guide (section 23.2).
3. The allowable span range is 75% to 133%. This range is ample to allow for correctly functioning Conductivity sensors. If calibration fails due to the k factor being outside these limits, then please consult the Troubleshooting guide (section 23.2) for possible remedies.
4. A Zero calibration should be performed at least monthly.
5. A Standard calibration should be performed at least weekly. Of course, more frequent calibration will result in greater confidence in results.
6. Conductivity and TDS calibration data are stored in a single area in memory. Ensure that the **hydroCHEM** has been correctly calibrated for the mode in which it will be used. The **hydroCHEM** may require re-calibration when alternating between Conductivity and TDS modes.
7. All calibration information is retained in memory when the **hydroCHEM** is switched off, even when the power supply is unplugged. This information can be recalled or printed later using the GLP function (see section 13).
8. The **hydroCHEM** displays the value of the standard to which it will attempt to calibrate. Ensure that the standard value displayed corresponds to the standard that you are using.

7.3 Conductivity Calibration Messages

1. If a Zero Calibration has been successfully performed, the **hydroCHEM** will display the following message and the Zero value of the sensor. For example...

Zero Calibration OK, Zero=0.1mS/cm

2. If a Standard Calibration has been successfully performed, the **hydroCHEM** will display the following message and the span value of the sensor. For example...

2.76mS/cm Calibration OK, Span=100.1%

3. If a Standard Calibration has failed, the **hydroCHEM** will display the following message and the failed span value of the sensor. For example...

2.76mS/cm Calibration Failed, Span=50.0%

8. TDS Calibration

Before attempting a TDS calibration ensure that Temperature has been correctly calibrated (see section 6). A “ * ” in the Temperature readout in place of the decimal point indicates that Temperature is NOT calibrated.

See section 17 for details on how to select TDS readout mode.



8.1 TDS Calibration Procedure

1. Ensure that the **hydroCHEM** is in Standby mode (see section 3.3).
2. Plug the Conductivity sensor into the **Cond/Temp** socket.
3. Rinse the sensor in distilled water. Shake off as much water as possible. Blot the outside of the sensor dry.

Zero Calibration

4. Let the sensor dry in air.
5. Select TDS Calibration ( → **F1: Calibrate** → **F1: TDS**).
6. The **hydroCHEM** will recognise the low TDS signal and attempt a Zero calibration. For example...

0*1ppK	25.0 ⁰ c
Press Enter to Calibrate to Zero	

7. When the reading has stabilised at or near zero, press  to calibrate or  to quit. The "*" will not be removed after a zero calibration.

Standard Calibration

8. Place the Conductivity sensor into a sample of 2.0 ppK standard so that it is immersed at least to the first vent hole, as per the diagram below.
DO NOT place the sensor directly into the bottle of standard. Discard the used sample of standard after use.

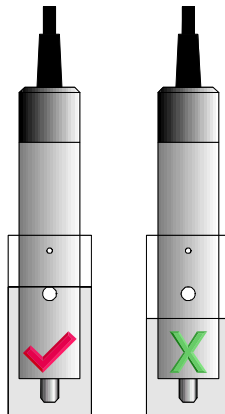

9. Select TDS Calibration ( → **F1: Calibrate** → **F1: TDS**). The calibration screen will be displayed, with the TDS standard to be used. For example...

2*1ppK	25.0 ⁰ c
Press Enter to Calibrate to 2.0ppK	

10. When the reading has stabilised, press  to calibrate. The "*" will now be replaced by a decimal point if calibration was successful.
11. The **hydroCHEM** is now calibrated for TDS and is ready for use in this mode.

8.2 TDS Calibration Notes

1. When a Zero calibration fails, span calibration is lost. Both a Zero and a Span calibration **MUST** be done once the problem has been remedied.
2. The allowable zero range for the Conductivity sensor is 0 to 0.1 ppK. If a zero calibration fails, please consult the troubleshooting guide (section 23.2).
3. The allowable span range is 75% to 133%. This range is ample to allow for correctly functioning Conductivity sensors. If calibration fails due to the k factor being outside these limits, then please consult the Troubleshooting guide (section 23.2) for possible remedies.
4. A Zero calibration should be performed at least monthly.
5. A Standard calibration should be performed at least weekly. Of course, more frequent calibration will result in greater confidence in results.
6. TDS and Conductivity calibration data are stored in a single area in memory. Ensure that the **hydroCHEM** has been correctly calibrated for the mode in which it will be used. The **hydroCHEM** may require re-calibration when alternating between Conductivity and TDS modes.
7. All calibration information is retained in memory when the **hydroCHEM** is switched off, even when the power supply is unplugged. This information can be recalled or printed later using the GLP function (see section 13).
8. The **hydroCHEM** displays the value of the standard to which it will attempt to calibrate. Ensure that the standard value displayed corresponds to the standard that you are using.

8.3 TDS Calibration Messages

4. If a Zero Calibration has been successfully performed, the **hydroCHEM** will display the following message and the Zero value of the sensor. For example...

Zero Calibration OK, Zero=0.1ppK

5. If a Standard Calibration has been successfully performed, the **hydroCHEM** will display the following message and the span value of the sensor. For example...

2.0ppK Calibration OK, Span=100.1%

6. If a Standard Calibration has failed, the **hydroCHEM** will display the following message and the failed span value of the sensor. For example...

2.0ppK Calibration Failed, Span=50.0%

9. pH Calibration

Before attempting a pH calibration ensure that Temperature has been correctly calibrated (see section 6). A “ * ” in the Temperature readout in place of the decimal point indicates that Temperature is NOT calibrated.

9.1 pH Calibration Procedure

1. Ensure that the **hydroCHEM** is in Standby mode (see section 3.3).
2. Plug the pH sensor into the **pH** socket and the Conductivity/Temperature sensor into the **Cond/Temp** socket. Switch the meter on.
3. Remove the wetting cap from the pH sensor. Rinse the sensors in distilled water. Shake off as much water as possible. Blot the outside of the sensors dry.
4. Ensure that the primary and secondary buffers to be used have been correctly selected for automatic buffer recognition. See section 20.
5. Place the pH sensor into a small sample of primary buffer (pH6.88 or 7.00). Ensure that the entire bulb and reference junction are immersed, as per the diagram below. Place the Conductivity/Temperature sensor into a separate beaker of liquid that is at the same temperature as the buffer (this is required for correct Temperature compensation).

DO NOT place the electrodes directly into the buffer bottle.

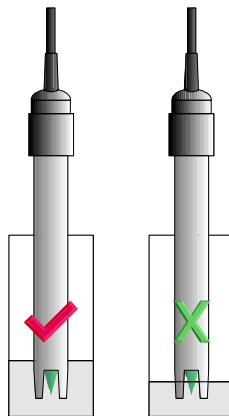

6. Select pH Calibration (Menu) → F1: Calibrate → F2: pH). The display should now look something like this...

6*7pH	Buffer= 6.9	25.0 ⁰ c
Press Enter to Calibrate, or Menu Exits		

The current pH reading is shown on the left. Note the “ * ”, indicating that pH is currently not calibrated. Wait for this reading to stabilise before attempting to calibrate the **hydroCHEM**.

The buffer that the **hydroCHEM** has attempted to recognise is also displayed with the correct value at the current temperature.

Press (Enter) to calibrate to the displayed buffer or (Menu) to quit without re-calibrating.

If a 1 point calibration has been performed, the "*" will not be removed until a full 2 point calibration has been performed.

7. Rinse the pH sensor in distilled water and blot dry.

- Place the pH sensor into a small sample of secondary buffer (pH4.00, 9.23 or 10.01). Ensure that the entire bulb and reference junction are immersed, as per the diagram in step 5, above. Place the Conductivity/Temperature sensor into a separate beaker of liquid that is at the same temperature as the buffer (this is required for correct Temperature compensation).

DO NOT place the electrodes directly into the buffer bottle.

NOTE: pH9.23 and pH10.01 buffers are highly unstable. Avoid using these buffers if possible. Discard immediately after use.

- Select pH Calibration (Menu) → F1: Calibrate → F2: pH). The display should now look something like this...

4*1pH	Buffer=	4.0	25.0 ⁰ c
Press Enter to Calibrate, or Menu Exits			

Note that the **hydroCHEM** has automatically recognised the second buffer.

Wait for the displayed reading to stabilise before attempting to calibrate the **hydroCHEM**.

Press (Enter) to calibrate to the displayed buffer or (Menu) to quit without re-calibrating.

- The **hydroCHEM** is now calibrated and is ready for use. Discard the used samples of buffer.

9.2 pH Calibration Notes

- The **hydroCHEM** has an allowable Asymmetry range of -1.00 to +1.00 pH. The allowable Slope range is 85.0 to 105.0 %. If calibration fails due to either the Asymmetry or the Slope being outside these limits, please consult the Troubleshooting guide (section 23.3) for possible remedies.
- A 1-point calibration should be performed at least weekly.
- A full 2-point calibration should be performed at least monthly. Of course, more frequent calibration will result in greater confidence in results.
- All calibration information is retained in memory when the **hydroCHEM** is switched off, even when the power supply is removed. This information can be recalled or printed later using the GLP function (see section 13).

9.3 pH Calibration Messages

1. If a 1-point calibration has been successfully performed, the **hydroCHEM** will display the following message and the asymmetry of the electrode. Note that the slope value from the last calibration is also shown. For example...

```
Asymmetry Calibration Successful
+0.10pH Asym      100.0% Slope
```

2. If a 1-point calibration has failed, the **hydroCHEM** will display the following message, and the failed asymmetry value of the electrode. For example...

```
Calibrate Failed, +1.1 pH Asymmetry
Repeat Cal. or Initialise Calibration
```

3. If a 2-point calibration has been successfully performed, the **hydroCHEM** will display the following message, and the asymmetry and slope of the electrode. For example...

```
Slope & Asymmetry Calibration Successful
+0.10pH Asym      99.0% Slope
```

4. If a 2-point calibration has failed, the **hydroCHEM** will display the following message, and the failed slope value of the electrode. For example...

```
Calibrate Failed, 80% Slope
Repeat Cal. or Initialise Calibration
```

10. Setting up the Sample Chamber

This section is applicable for the **hydroCHEM** Dosing System, which has the flow-through sample chamber installed on a mounting board with the **hydroCHEM** unit.

10.1 Connecting the tubing

The **hydroCHEM** Dosing System is supplied with 10 metres of 13 mm black polyethylene tubing. The input tubing should be connected to a take-off on the output side of the crop feeding pump. Alternatively, if a separate mixing pump is being used in the main tank, it can be connected on the output side of this. The sample chamber is not designed to take the full pressure of the entire flow of nutrient to the crop. It is designed to monitor just a small sample.

The normal output fitting is on the right hand side of the sample chamber. This should be run back to the main tank downwards in as straight a line as possible. Do not coil the output tubing.

The sample/drain tap is provided for two reasons. Firstly, it allows the operator to obtain a sample of nutrient from the flow chamber. This may be required if the nutrient is to be checked by another instrument for example. The second use of the sample/drain tap is to completely drain the sample chamber. This makes the process of cleaning easier, as it avoids a splash of nutrient when the lid of the sample chamber is removed. A tube may be fitted to this if required, although it is not essential. Run any tube back to the main tank downwards in as straight a line as possible. Do not coil the tubing.

The emergency overflow fitting is very important. It has been fitted to provide a vent, should the normal overflow tubing become blocked. Fit as short a run of tubing to this fitting as possible. Run the tubing back to the main tank downwards in as straight a line as possible. Do not coil the output tubing.

The diagram below shows a sample chamber with all tubing fitted.

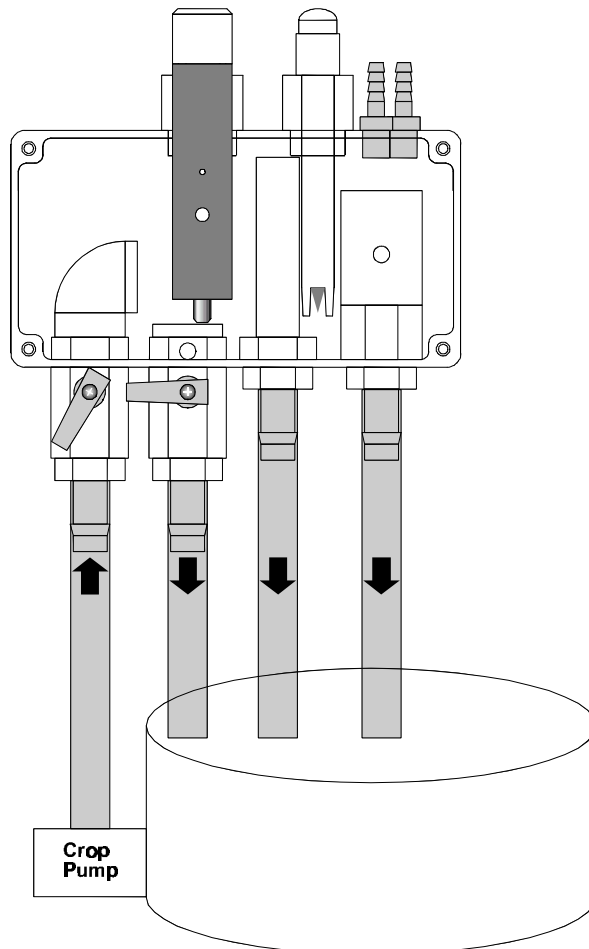

10.2 Adjusting the Flow Rate

The correct flow rate is achieved when the nutrient flows over the top of the normal overflow fitting. The flow should not completely fill the sample chamber, as this will cause pressure which may make the sample chamber leak. If the flow is not sufficient to cause the nutrient to flow over the top of the normal overflow fitting, then Conductivity readings will be too low or the **hydroCHEM** may even register a No Flow condition.

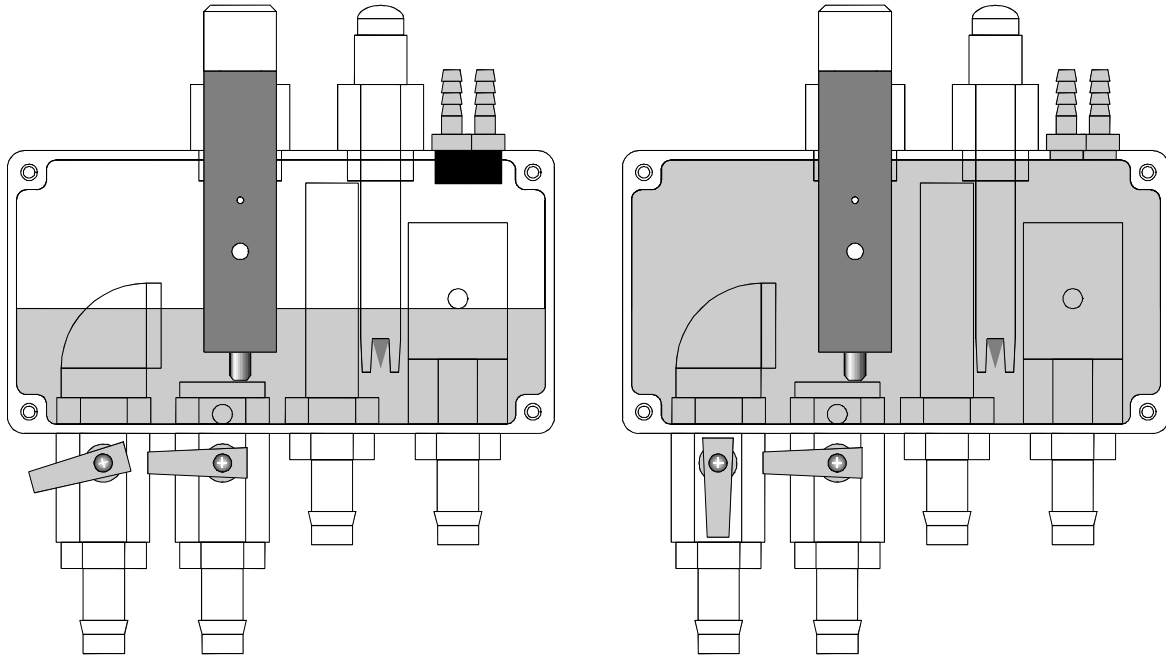

Flow too low

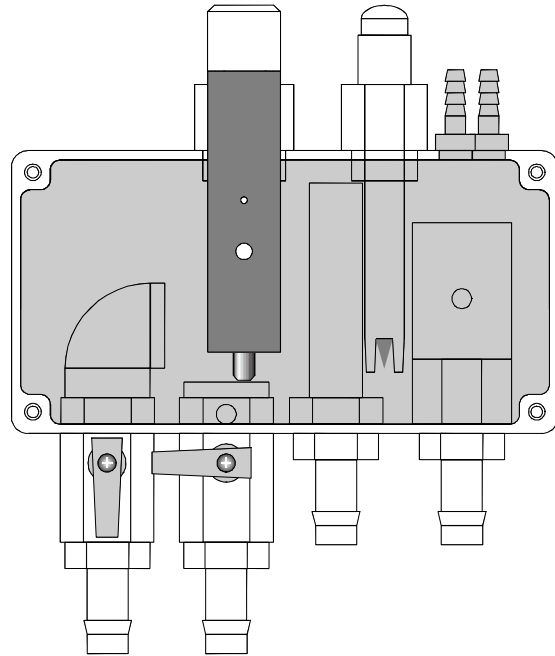

Flow too high

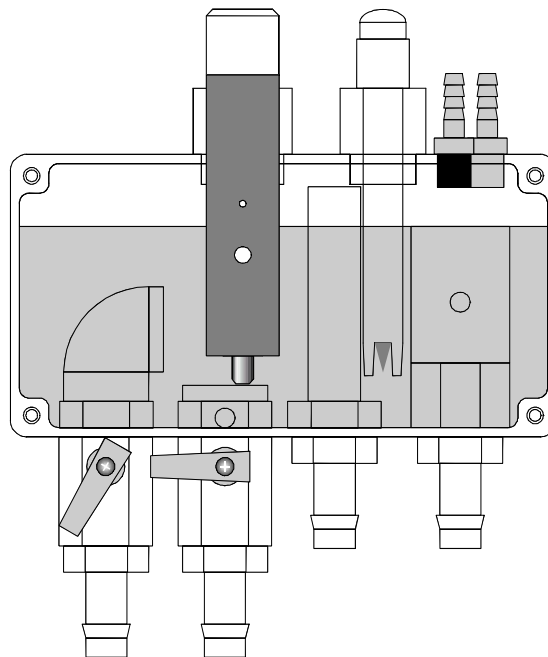

Flow OK

11. Peristaltic Pumps

This section is applicable to the **hydroCHEM-P** (part number 111105) and the **hydroCHEM-DS** (part number 111109), which are fitted with peristaltic dosing pumps.

11.1 Lubricating the Pump Tubing

The **hydroCHEM** is shipped without lubrication on the peristaltic pump tubing. This is to avoid dust or other particles sticking to the tubes during packing and transit. These particles can cause premature wearing of the pump tubing. The **hydroCHEM** is supplied with a 3 mL syringe of Silicon grease to lubricate the tubes.

To lubricate the pump tubing...

1. Unscrew and remove the pump pressure plates.
2. Smear a small quantity of Silicon grease all around each tube.

NOTE

DO NOT use petroleum based oil or lubricants, as these will cause the Viton rubber to perish. Use only Silicon based lubricant.

11.2 Priming the Pumps

Once the pump tubing has been lubricated, the pumps can be primed. The left side pump has two tubes for A Nutrient and B Nutrient. The right side pump is for pH adjustor. The pumps may be primed separately or at the same time.

To prime the pumps...

1. Replace the pump pressure plates, and partially screw in the retaining screws.
2. Run the suction side tubes into the A Nutrient, B Nutrient and pH adjustor drums. A small weight may be attached to the end of the tubing to ensure it rests on the bottom of the drum.
3. Run the output side of the tubing downwards to the main nutrient mixing tank in as straight a line as possible. Do not coil the output tubing.
4. Start the pumps. The Quick Dose function is ideal for this purpose (see section 4). It should only take 2 to 3 minutes to prime the pumps.
5. Tighten the retaining screws until the pumps start to suck up Nutrient and pH adjustor. Try to screw each retaining screw in about the same distance to keep the pressure plate level. Ensure that both A Nutrient and B Nutrient are being sucked up. Do not be concerned if A and B Nutrient are not being sucked up at the same rate at this point. Once all of the air in the tube on the suction side of the pump has been expelled, the A and B Nutrient will added in a 1:1 ratio (to within 3%).
6. When the A Nutrient, B Nutrient and pH adjustor have been sucked up to and through the pumps, the Quick Dose cycle can be switched off by pressing the  key.

11.3 Pump Maintenance

The pump pressure plate should be removed and the pump cleaned on a regular basis. If this is not done, abrasion due to dirt and dust build-up could shorten the life of the Viton tubing and rollers.

11.4 Replacing the Pump Tubing

Replace the Pump Tubing if it gets worn, begins to leak, or pumping volume is reduced.

To replace the Pump Tubing...

1. Pull the barb fittings off the end of the Pump Tubing.
2. Unscrew and remove the pump pressure plates.
3. Pull out the worn tubing.
4. Feed a new piece of tubing through the holes each side of the rotor. Turn the rotor by hand if necessary to expose the tube holes.

If non-genuine tubing is used, ensure that it has an outside diameter of 6.0 mm, inside diameter of 4.0 mm, and at least 200 mm long. A chemical resistant material such as Viton or Tygon should be used.

5. Fit the small end of the barb fittings to each end of the Pump Tubing. A small amount of Silicone-based lubricant may assist in getting the tube all the way onto the barb.

DO NOT use petroleum based oil or lubricants, as these will cause the Viton rubber to perish. Use only Silicon based lubricant.

6. Reconnect the input and output hoses.

Lubricate the tubing as per section 11.1.

Replace the pressure plate and prime the pump as per section 11.2.

11.5 Tube Saver Feature

To help prevent premature wear of the pump tubing, the **hydroCHEM** has an exclusive Tube Saver feature.

The **hydroCHEM** advances the rotor approximately 1/4 of a turn every hour, so that the pump tubing is not squeezed at the same point for extended periods of time.

This function only operates when the **hydroCHEM** is switched on. If the **hydroCHEM** is going to be left unused and switched off for extended periods of a few days or more, loosen the pressure plate retaining screws. The pumps will need to be re-primed if this is done (see section 11.2).

12. Password Security

The password security feature prevents unauthorised persons from accessing any of the menu functions of the **hydroCHEM**.

12.1 Enabling the Password Security function.

1. Select the Password menu (Menu → F5: System → F1: Password).
2. Select **F3: Enable Security & Enter Code** from the menu.
3. The **hydroCHEM** now prompts you to enter a 4 digit password...

Enter NEW 4 digit access code : _
Press F1, F2, F3, F4, F5 to Enter code

Press any combination of 4 of the F1 to F5 keys. Any of the keys may be repeated as often as you wish. You do not need to press Enter after pressing the 4th key.

4. The **hydroCHEM** now prompts you to re-enter the password for verification...

Enter NEW 4 digit access code : _
Now Re-Enter for Verification

Re-enter the 4 digit password. You do not need to press Enter after pressing the 4th key.

5. The **hydroCHEM** now confirms that Security Access is enabled before returning to the Password menu.

12.2 Using the Password Security function

When the Password Security function is enabled (as per section 12.1), the **hydroCHEM** prompts the operator to enter the password whenever the Menu key is pressed in normal display mode. No further password entry is required to access any of the menu functions. It is therefore imperative never to remain in any of the menus when leaving the unit. Always press the Menu key until the **hydroCHEM** is in normal display mode before leaving the unit.

Notes

1. If you wish to write the Password down, it is advisable to do so somewhere away from the unit.
2. If you forget the Password, please contact TPS. Once we have established your ownership of the unit, we will be able to give you an access code. We will need the serial number of the unit to provide this code.

12.3 Changing the Password

1. Select the Password menu (Menu → F5: System → F1: Password).
(Of course, you will need to enter the current password after pressing the Menu key.)
2. Select F1: Change Code from the menu.
3. The **hydroCHEM** now prompts you to enter a new password...

Enter NEW 4 digit access code : _
Press F1, F2, F3, F4, F5 to Enter code

Press any combination of 4 of the F1 to F5 keys. Any of the keys may be repeated as often as you wish. You do not need to press Enter after pressing the 4th key.

6. The **hydroCHEM** now prompts you to re-enter the password for verification...

Enter NEW 4 digit access code : _
Now Re-Enter for Verification

Re-enter the 4 digit password. You do not need to press Enter after pressing the 4th key.

4. The **hydroCHEM** now confirms that the new Password has been saved before returning to the Password menu.

12.4 Disabling the Password Security function

1. Select the Password menu (Menu → F5: System → F1: Password).
(Of course, you will need to enter the current password after pressing the Menu key.)
2. Select F3: Disable Security from the menu.
3. The **hydroCHEM** now confirms that Security Access has been disabled before returning to the Password menu.

13. Good Laboratory Practices (GLP)



To comply with GLP guidelines, the **hydroCHEM** keeps a record of the last Conductivity (or TDS), pH, and Temperature calibrations plus all system set-up information. This information is retained in memory when the **hydroCHEM** is switched off, even when the power supply is removed.

13.1 Recalling Calibration information on the display

1. Select the GLP menu (Menu) → F5: System → F2: GLP).
2. Select F1: Recal 1 Cal . from the menu.
3. The instrument model, firmware version number, and instrument serial number are displayed, along with a prompt describing how to scroll through the Calibration information.

The date and time are displayed only when the Plus-Pack is fitted.

```
hydroCHEM+ V1.0 R1234 @ 31/12/99 12:00
                ↑: Next
```

4. Press the  key to sequentially scroll through the Calibration information for all parameters. Press the  key to scroll back to previous data. The sequence of information displayed is shown below. Press (Menu) to abort at any time.

Calibration Data Display sequence...

```
hydroCHEM+ V1.0 R1234 @ 31/12/99 12:00
                ↑: Next
```

```
Cond. Zero=0.00mS/cm      31/12/99 10:00
Cond. Calibrated          ↑: Next ↓: Back
```

```
Cond. Span=100.0%        31/12/99 10:10
Cond. Calibrated          ↑: Next ↓: Back
```

```
pH Asymmetry=0.10pH     31/12/99 10:20
pH Calibrated            ↑: Next ↓: Back
```

```
pH Slope=100.0%         31/12/99 10:30
pH Calibrated            ↑: Next ↓: Back
```

```
Temperature Offset=0.1°C 31/12/99 10:40
Temp. Calibrated         ↑: Ends ↓: Back
```

13.2 Printing Calibration information to the RS232 Port

The GLP information stored in the instrument's memory can be sent to a printer or PC via the RS232 port. This function is available only when the Plus-Pack is fitted.

1. Ensure that the **hydroCHEM** RS232 cable is connected to the instrument and to the printer or PC.
2. Select the GLP menu (Menu) → **F5: System** → **F2: GLP**).
3. Select **F2: Print Cal.** from the menu.

The message "Printing GLP Data" is displayed while sending the data to the RS232 port.

4. The Calibration information is sent to the RS232 port in formatted ASCII text. For example...



```
hydroCHEM V1.0 R1234 @ 31/12/1999 12:00
Cond.      Zero=      0.00mS/cm @ 31/12/1999 10:00
Cond.      Span=     100.0%   @ 31/12/1999 10:10
pH         Asy=       0.10pH   @ 31/12/1999 10:20
pH         Slope=    100.0%   @ 31/12/1999 10:30
Temperature Offset= 0.1oC    @ 31/12/1999 10:40
ENDS
```

13.3 Recalling System information on the display

1. Select the GLP menu (Menu) → **F5: System** → **F2: GLP**).
2. Select **F3: Recall Sys.** from the menu.
3. The instrument model, firmware version number, and instrument serial number are displayed, along with a prompt describing how to scroll through the System information. For example...

hydroCHEM+ V1.0 R1234	↑: Next
@ 31/12/99 12:00	

(The date and time are displayed only when the Plus-Pack is fitted.)

4. Press the  key to sequentially scroll through the System information for all parameters. Press the  key to scroll back to previous data. The sequence of information displayed is shown over the page. Press (Menu) to abort at any time.

System Data Display sequence...

hydroCHEM+ V1.0 R1234 @ 31/12/99 12:00	↑: Next
Cond. Zero=0.00mS/cm Cond. Span=100.0%	↑: Next ↓: Back
pH Asymmetry=0.10pH pH Slope=100.0%	↑: Next ↓: Back
Temperature Offset=0.1 ⁰ c	↑: Next ↓: Back
Primary Buffer=6.88pH Secondary Buffers=4.00/9.22pH	↑: Next ↓: Back
Cond. Limit=2.0mS/cm Add if Low Cond. Sensitivity=Medium	↑: Next ↓: Back
Cond. ON Time=5 minutes Cond. OFF Time=10 minutes	↑: Next ↓: Back
Cond. ShutOFF Timer=60 minutes Cond. Quick Dose Time=5 minutes	↑: Next ↓: Back
pH Limit=6.5pH Add if High pH Sensitivity=Medium	↑: Next ↓: Back
pH ON Time=5 minutes pH OFF Time=10 minutes	↑: Next ↓: Back
pH ShutOFF Timer=15 minutes pH Quick Dose Time=5 minutes	↑: Ends ↓: Back

When the Plus-Pack is fitted, an additional screen showing the currently selected RS232 baud rate is provided.

13.4 Printing System information to the RS232 Port

The System information stored in the instrument's memory can be sent to a printer or PC via the RS232 port. This function is available only when the Plus-Pack is fitted.

1. Ensure that the **hydroCHEM** RS232 cable is connected to the instrument and to the printer or PC.
2. Select the GLP menu ( → **F5: System** → **F2: GLP**).
3. Select **F4: Print Sys.** from the menu.

The message "Printing System Data" is displayed while sending the data to the RS232 port.

4. The System information is sent to the RS232 port in formatted ASCII text. For example...

```
hydroCHEM V1.0 R1234 @ 31/12/1999 12:00
Cond.      Zero=      0.00mS/cm @ 31/12/1999 10:00
Cond.      Span=     100.0%   @ 31/12/1999 10:10
pH         Asy=      0.10pH   @ 31/12/1999 10:20
pH         Slope=    100.0%   @ 31/12/1999 10:30
Temperature Offset= 0.1oC    @ 31/12/1999 10:40
Primary Buffer=6.88pH
Secondary Buffers=4.00/9.22pH
Cond. Limit=2.0mS/cm Add if Low
Cond. Sensitivity=Medium
Cond. ON Time=5 minutes
Cond. OFF Time=10 minutes
Cond. Shutdown Timer=60 minutes
Cond. Quick Dose Time=5 minutes
pH Limit=6.5pH Add if High
pH Sensitivity=Medium
pH ON Time=5 minutes
pH OFF Time=10 minutes
pH Shutdown Timer=15 minutes
pH Quick Dose Time=5 minutes
Baud Rate=9600
ENDS
```

13.5 Failed Calibration

If calibration has failed, the display the message "Un- Cal i brated" for any parameter that has failed calibration. The date and time for the failed calibration is reset to zero when the Plus-Pack is fitted. The **hydroCHEM** still shows the results for the last successful calibration, as shown in the following example...

1. Failed Conductivity span calibration for standard **hydroCHEM**...

Cond. Span= 95.0%	
Cond. Un- Cal i brated	↑: Next ↓: Back

2. Failed pH Asymmetry Calibration for **hydroCHEM** with Plus-Pack fitted...

pH Asymmetry=0.10pH	00/00/00 00:00
pH Un- Cal i brated	↑: Next ↓: Back

13.6 Instrument Serial Number

In case the serial number that is fitted to the **hydroCHEM** is removed or becomes illegible, it is also available on the **hydroCHEM** display.

1. The serial number is displayed at turn-on, for example...

hydroCHEM+ V1.0 R1234 (C) 1999 TPS P/L
Hydroponi cs Controller

The "+" after **hydroCHEM** is shown when the Plus-Pack is fitted

2. The serial number is displayed when recalling the Calibration or System information (sections 13.1 and 13.3).
3. The serial number is included on the printout of Calibration or System information (sections 13.2 and 13.4).
4. The GLP information can be downloaded to a PC using the optional Windows ® software (part number 130086).

13.7 Additional GLP Features

Another GLP requirement is to record the date and time of every reading. The **hydroCHEM** does this for you when readings are recorded either with the Notepad function (section 14.1) or the Automatic Logging function (section 14.2). These functions are available only when the Plus-Pack is fitted.

14. Datalogging Function

The Datalogging function is available only when the Plus-Pack is fitted.

14.1 Recording readings manually

To manually record readings into memory...

1. Press **F1** in normal display mode. The display should now look like this example...

1. 9mS/cm (2.0)	6. 6pH (6.5)	25.0°C
Log# 1, Press F1		12:00

2. Press **F1** to record Conductivity/TDS, pH, Temperature, Date and Time into memory. This will be labelled as reading number 1.

Alternatively, press **Menu** to quit without recording the reading.

3. Repeat steps 1 & 2 as often as required. The maximum number of readings that can be stored in the Notepad is 2300.

14.2 Recording readings automatically

The **hydroCHEM** can automatically log records into memory or to the RS232 port. First the logging period must be programmed, then automatic logging can be started and stopped as required.

To program the logging period...

1. Select the Logger menu (**Menu** → **F4: Logger**).

2. Select **F4: Program** from the menu.

The display should now look similar to that shown below. The current Logging Period is displayed.

Enter Logging Period : 1 Hour
Press ↑↓ to select period

3. Use the **↑** and **↓** keys to set the period at which the **hydroCHEM** will automatically log records into memory or to the RS232 port. The available logging periods are 1, 2, 5, 10, 15, 20 and 30 minutes and 1, 2, 3, 4, 6, 8, 12 and 24 hours. These periods have been chosen because they divide evenly into a 24 hour day.

Press **Enter** to save the Logging Period.

Press **Menu** to quit without changing the current setting.

4. The automatic logging function is now programmed and can be enabled or disabled as required.

To enable automatic datalogging...

1. Select the Logger menu ( → **F4: Logger**).
2. Select **F5: Enable** from the menu to enable automatic datalogging.
3. The **hydroCHEM** now confirms that automatic datalogging is enabled, and gives you the choice of logging into memory, or sending readings directly to the RS232 port...

Data Logging Enabled		
F1: Log Data	F2: Send to RS232	

Press  to log the data into the **hydroCHEM** memory whenever a reading is due.

Press  to send the data directly to the RS232 port whenever a reading is due.

NOTE: The  key is not available to quit at this point, as logging has already been enabled.

4. The **hydroCHEM** calculates a "logical" time for the next reading to be logged, so that readings are logged at even times during the 24 hour day.

For example, if the logging period is set to 2 hours, the **hydroCHEM** will log at 12:00, 2:00, 4:00 etc. Even if logging is enabled at an odd time such as 12:23, the unit will wait until 2:00 before recording the first reading. This feature makes data much easier to examine visually later.

5. When logging data into memory, the **hydroCHEM** alternates between the next log number and the time the next reading is due to be logged on the display.

When sending data to the RS232 port, the **hydroCHEM** alternates between the word "#Send" and the time the next reading is due to be sent on the display.

To disable automatic datalogging...

1. Select the Logger menu ( → **F4: Logger**).
2. Select **F5: Disable** from the menu to enable automatic datalogging.
3. The **hydroCHEM** confirms that automatic datalogging has been disabled.

14.3 Recalling Readings from the Notepad

To recall records from memory onto the **hydroCHEM** display...

1. Select the Logger menu ( → **F4: Logger**)
2. Select **F1: Recall** from the menu.



Record number 1 is now displayed.

For example...

1. 8mS/cm Offline	7. 6pH OK	25. 0°C
Log#1,	31/12/99	12:00

3. Press  to display the next record.

Press  to display the previous record.

Press and hold the  key while pressing the  and  keys to roll rapidly through the readings.

Press  to send the displayed record to the RS232 port.

14.4 Erasing Records from the Notepad



To erase records from the Notepad...

1. Select the Logger menu ( → **F4: Logger**).
2. Select **F2: Erase** from the menu.
3. The **hydroCHEM** now displays the Erase menu, for example...

```

Erase Log, ( 2300 ) Select Option
F1: Erase All  F2: Erase Last  Menu Exits
  
```



The number of readings stored in memory is displayed. See the “2300” in the example above.

4. Press  to erase all of the readings stored in the Notepad.
Press  to erase the last recorded reading only.
Press  to quit without erasing any records.

14.5 Printing Records from the Notepad to the RS232 Port

1. Connect one end of the RS232 cable to the **Power/RS232** socket of the **hydroCHEM**.
2. Connect the other end of the RS232 cable to an RS232 Printer, or to the COM1 or COM2 ports of a PC.
3. Ensure that the baud rate for the printer or PC and the **hydroCHEM** are the same. If necessary, alter the baud rate of the **hydroCHEM** (see section 15.1).

The **hydroCHEM** uses XON/XOFF protocol. Ensure that the printer is set accordingly.

4. Select the Logger menu ( → **F4: Logger**).
5. Select **F3: Print** from the menu.
6. Printing starts as soon as  is pressed. The following screen is displayed while the readings are being sent to the RS232 port...

```

Printing Data . . .
                                Press Menu to Quit
  
```

Press  at any time to stop sending the readings to the RS232 port.

15. RS232 Port





This section is applicable when the Plus-Pack is fitted.

15.1 Setting the Baud Rate

1. Select the Baud rate menu ( → F5: System → F4: Baud).
2. The available baud rates are listed, along with the RS232 port configuration...

Baud Rate: F1: 300 F2: 1200 →F3: 9600 8 bits, No Parity, 1 Stop bit, XON/XOFF

The arrow indicates the current selection.

3. Press  to select 300 baud.
 Press  to select 1200 baud.
 Press  to select 9600 baud.
 Press  to quit and retain the current setting.

15.2 Sending Readings to the RS232 Port

Press  to instantly send readings to the RS232 port whenever the **hydroCHEM** is in normal display mode.

Records can be sent directly to the RS232 port rather than stored in memory during automatic datalogging. See section 14.2 for details.

Press  while recalling data on the display (see section 14.3) to send that record to the RS232 port.

15.3 RS232 Configuration

The **hydroCHEM** RS232 configuration is 8 Bits, No Parity, 1 Stop Bit, XON/XOFF Protocol.

This information is displayed when setting the baud rate (see section 15.1)

15.4 Communication and Statistical Software

Communication between the **hydroCHEM** and a PC can be handled with any RS232 communication software. The diskette supplied by TPS contains a BASIC program for this purpose. A Windows version is also optionally available (part number 130086).

Once the data is saved to disk, the next problem is how to use it. The data sent by the **hydroCHEM** is formatted in columns that can be imported by programs such as Microsoft[®] Excel[®] and Lotus 123[®].

Information on how to use the software is provided in the README files on the diskette.

15.5 Commands

The following commands can be sent from a PC to the **hydroCHEM**. Note that <cr> denotes carriage return and <lf> denotes a line feed.

Action	Command	Notes
Request current data	?D<cr>	Returns the current Conductivity/TDS, pH and Temperature data, Control status, date and time from the hydroCHEM . The log number returned is set to Zero.
Request logged data	?R<cr>	Returns all logged records from the hydroCHEM memory. The data ends with the message ENDS <cr>
Erase logged data	?E<cr>	Erases all logged records from the hydroCHEM memory. Returns the message ERASED <cr> to confirm that the records have been erased.
Request status information	?S<cr>	Returns the model name, firmware version number, instrument serial number and number of logged readings in memory, for example... hydroCHEM•V1.0•R1234•2300 <cr>, where • are spaces. Note that the number of logged readings is right-justified.
Request GLP information	?G<cr>	Returns all calibration and system set-up information, instrument model, serial number and current date (see section 15.7 for data format and handshaking).

15.6 Data Format

Data is returned to the RS232 Port by the **hydroCHEM** in the following format...

LLLL•CCCCCCcccc•SSSSSSSS•PPPPPPppp•SSSSSSSS•TTTTTTt t t •dd/mm/yyyy•hh: mm

where....

LLLL is the Log Number, 4 characters, right justified. The **hydroCHEM** sends a Zero for instant readings (see section 15.2).

• is one space

CCCCCC is the Conductivity/TDS data, 6 characters, right justified. The data is replaced by 6 spaces when there is no flow through the sample chamber.

cccc is the Conductivity/TDS unit description, which can be any one of the following...

mS/cm	for millisiemens per centimetre in Conductivity mode.
CF•••	for CF Units in Conductivity mode.
dS/M•	for decisiemens per metre in Conductivity mode.
ppK••	for parts per Thousand in TDS mode.
(“•” is one space.)	

• is one space.

SSSSSSSS is the Conductivity Control Status.

• is one space.

PPPPPP is the pH data, 6 characters, right justified. The data is replaced by 6 spaces when there is no flow through the sample chamber.

ppp is the pH unit description, sent as "**pH•**" where "**•**" is one space.

• is one space.

SSSSSSSS is the pH Control Status.

• is one space.

TTTTTT is Temperature data, 6 characters, right justified. The data is replaced by 6 spaces when there is no flow through the sample chamber.

t t t is the unit description, sent as "**oC•**", where "**•**" is one space.

• is one space.

dd/mm/yyyy is the date, month and year data. The year is sent as 4 digits for Year 2000 compliance.

• is one space

hh: mm: ss is the hours, minutes and seconds data.

When requested by a PC with the ?D or ?R commands (section 15.5), the data is terminated with a carriage return.

When the data is sent by the **hydroCHEM** using the Print function (section 14.5) or the Instant Send function (section 15.2), the data ends with a carriage return and a line feed.

15.7 GLP Data Format

Calibration and system information is returned as 21 lines terminated by a carriage return. When using the "?G" command (section 15.5), the computer must respond with a character after receiving each line.



For example...

```
hydroCHEM V1.0 R1234 @ 31/12/1999 12:00
Cond.      Zero=      0.00mS/cm @ 31/12/1999 10:00
Cond.      Span=      100.0%   @ 31/12/1999 10:10
pH         Asy=       0.10pH   @ 31/12/1999 10:20
pH         Slope=     100.0%   @ 31/12/1999 10:30
Temperature Offset=  0.1oC    @ 31/12/1999 10:40
Primary Buffer=6.88pH
Secondary Buffers=4.00/9.22pH
Cond. Limit=2.0mS/cm Add if Low
Cond. Sensitivity=Medium
Cond. ON Time=5 minutes
Cond. OFF Time=10 minutes
Cond. Shutdown Timer=60 minutes
Cond. Quick Dose Time=5 minutes
pH Limit=6.5pH Add if High
pH Sensitivity=Medium
pH ON Time=5 minutes
pH OFF Time=10 minutes
pH Shutdown Timer=15 minutes
pH Quick Dose Time=5 minutes
Baud Rate=9600
ENDS
```

16. Setting the Clock

1. Select the Clock Set-up menu (Menu → F5: System → F3: Clock)
2. The Clock Set screen is now displayed, with the current date and time. The cursor is on the day of the month. For example...

<p>Set Clock 3<u>1</u>/12/99 12: 00 Press Enter to Save, menu to Quit</p>





Use the  and  keys to set the day of the month.

Press the  key to move to the month, then use the  and  keys to set the month.

Press the  key to move to the year, then use the  and  keys to set the year.

Press the  key to move to the hours, then use the  and  keys to set the hours.

Press the  key to move to the minutes, then use the  and  keys to set the minutes.

3. If any corrections are required, use the  and  keys to move the cursor between the various elements of the date and time.
4. Press  to save the new date and time.
5. Alternatively, press  to quit and retain the current setting.

Notes

1. The **hydroCHEM** tests that a valid day of the month is entered. If an invalid date is entered (eg. 31/09/99), the **hydroCHEM** beeps and displays the message “**Invalid Date**”. The meter then returns to the clock setting screen, so that the correct date can be entered.
2. The **hydroCHEM** also tests for leap years.
3. The microprocessor in the **hydroCHEM** only stores the year to two digits, however this presents no Year 2000 problems. The TPS software automatically converts the date to four digits when downloading data.

17. Selecting the Conductivity/TDS units

The **hydroCHEM** can display Conductivity in mS/cm, CF units and dS/m. It can also display TDS in ppK.

To select the Conductivity/TDS units...

1. Select the Units menu (Menu) → F5: System → F5: Setup → F1: Units)...

UNI TS	→F1: mS/cm	F2: ppK (TDS)
	F3: CF	F4: dS/M

The arrow indicates the current selection.

2. Press F1 to display Conductivity in mS/cm (millisiemens per centimetre).

Press F2 to display TDS in ppK (parts per Thousand).

Hint: Multiply this reading by 1000 for ppM (parts per Million)

Press F3 to display Conductivity in CF units.

Press F4 to display Conductivity in dS/m (decisiemens per metre).

Press Menu to quit and retain the current setting.

3. The **hydroCHEM** confirms the selected units before returning to the Setup menu.

18. Selecting Display Resolution

This section is applicable when the Plus-Pack is fitted.

To select low or high display resolution, when the Plus-Pack is fitted...

1. Select the Resolution menu (Menu) → F5: System → F5: Setup → F2: Resolution)...

Select Resolution	→F1: Low	F2: High
-------------------	----------	----------

The arrow indicates the current selection.

Press F1 to select low resolution.

Press F2 to select high resolution.

Press Menu to quit and retain the current setting.

2. After pressing F1 or F2 the **hydroCHEM** confirms the display resolution for both Conductivity/TDS (in currently selected units) and pH. For example...

. 1mS/cm	. 1pH resolution selected
----------	---------------------------

The following table listed the low and high resolutions for the various Conductivity/TDS units and pH...

	Low Resolution	High Resolution
Conductivity mS/cm	0.1	0.01
TDS ppK	0.1	0.01
Conductivity CF units	1	0.1
Conductivity dS/m	0.1	0.01
pH	0.1	0.01

19. Emergency ShutOFF timer

The emergency ShutOFF timer shuts the Conductivity and/or pH pumps down if they have operated continuously for a preset time, without the readings coming back to within the limits. For example, this condition could occur if the sensor is faulty and is giving an incorrect reading or if the added chemicals were not able to be seen by the sensors. The ShutOFF feature provides a safeguard against dosing entire nutrient and/or acid tanks to the crop. To set the ShutOFF time...

1. Select the Setup menu (Menu → F5: System → F5: Setup).
2. Select F3: ShutOFF from the menu. The **hydroCHEM** now allows you to enter the maximum time for which the Conductivity pump will operate, without getting back to within the limit...

Enter Cond. ShutOFF Timer : 60 minutes

Use the ↑ and ↓ keys to set the required time, from 10 to 240 minutes.

Press and hold the Shift key at the same time as the ↑ and ↓ keys to scroll keys to scroll rapidly.

3. Press Enter to save the ShutOFF timer setting for the Conductivity pump.
Press Menu to quit and retain the current setting.
4. If Enter was pressed, above, the **hydroCHEM** will now allow you to enter the maximum time for which the pH pump will operate, without getting back to within the limit...

Cond. ShutOFF Timer : 60 minutes
Enter pH ShutOFF Timer : 15 minutes

Use the ↑ and ↓ keys to set the required time, from 5 to 240 minutes.

Press and hold the Shift key at the same time as the ↑ and ↓ keys to scroll keys to scroll rapidly.

5. Press Enter to save the ShutOFF timer setting for the pH pump.
Press Menu to quit and retain the current setting.

19.1 Procedure in event of ShutOFF timer being tripped

When the ShutOFF timer has been tripped, the word "ShutOFF" is displayed as the status for the relevant reading and the **hydroCHEM** beeps.

To re-set the ShutOFF timer, press the Menu key.

No further automatic control will occur for that parameter until the Menu key is pressed.

The condition that caused the ShutOFF timer to trip must be rectified to avoid it being tripped again. This may involve one or more of the following...

- Re-fill the A Nutrient, B Nutrient, or pH adjustor drum if they were empty.
- Check and re-calibrate the Conductivity and/or pH sensors to ensure the reading is actually correct.
- Extend the ON time if the pump rate is not high enough to keep up with chemical demand for the current ON time.
- Place the chemical addition point as close as practical to the sensors in the main tank. If a **hydroCHEM-DS** with in-built sample chamber is being used, place the pick-up point for the sample chamber as close as possible to the drain from the overflow pipe.

20. Selecting Buffers for Auto Buffer Recognition

The **hydroCHEM** is factory set to automatically recognise pH4.00, pH6.88 and pH9.23 buffers. However, some users may prefer to use pH7.00 instead of pH6.88 and pH10.06 instead of pH9.23. The following procedure describes how to set which of these buffers are automatically recognised at calibration.

1. Select the Setup menu ( → **F5: System** → **F5: Setup**).
2. Select **F4: Buffer** from the menu. The **hydroCHEM** now prompts you to select the Primary Buffer you wish to use for calibration...



<p>Select Primary Buffer →F1: 6.88pH F2: 7.00pH</p>
--

The arrow indicates the current selection.

Press  to select pH6.88 as the primary buffer.

Press  to select pH7.00 as the primary buffer.

Press  to quit and retain the current buffer settings.

3. If  or  was press above, the **hydroCHEM** will now prompt you to select the Secondary pH Buffers you wish to use for calibration...

<p>Select Secondary Buffers →F1: 4.00/9.22pH F2: 4.00/10.06pH</p>
--

The arrow indicates the current selection.

Press  to select pH4.00 and pH9.23 as the secondary buffers.

Press  to select pH4.00 and pH10.06 as the secondary buffers.

Press  to quit and retain the current buffer settings.

Note: pH6.88 buffer is a DIN 19266 and NBS Primary-standard pH solution. Its use is highly recommended for the most accurate possible results. If pH7.00 buffer is used, ensure that it is manufactured to 0.01pH accuracy. pH7.00 buffer has a buffer capacity less than half that of pH6.88 buffer and is therefore much less stable.

21. Resetting the hydroCHEM

The calibration information and the full system set-up information can be reset to factory defaults, if required. This allows the operator to set up and calibrate the unit from the beginning, with a clean system.

21.1 Resetting the Calibration information only

1. Select the Reset menu ( → F5: System → F5: Setup → : F5: Reset).
2. Select F1: Calibration only from the menu.
3. The following message is now displayed...

Calibration Reset
Unit should be Re-calibrated before use.

4. The **hydroCHEM** now returns to the Setup menu. Note that in the decimal points will be replaced with a “ * ” in normal display mode, to indicate that the unit must be re-calibrated.

21.2 Resetting the Full System information

1. Select the Reset menu ( → F5: System → F5: Setup → : F5: Reset).
2. Select F2: Full System from the menu.
3. The following message is now displayed...

Reset Full System, Are you sure ?
F1: Yes F2: No

Press  to reset all calibration, limit and control settings to factory defaults.

Press  to quit without resetting the system.

5. The following message is displayed when the full system is reset...

System Reset
All Calibration and Control values RESET

21.3 Factory Default System Settings

The factory default calibration and system settings are as follows...

Conductivity

Sensor Zero : 0.00 mS/cm
Sensor Span : 100.0 %
Control Limit : 2.0 mS/cm
Control Direction : Add if Low
Control Sensitivity : Medium
Control ON Time : 5 Minutes
Control OFF Time : 10 Minutes
ShutOFF Timer : 60 Minutes
Quick-Dose Time : 5 Minutes

pH

Sensor Asymmetry : 0.00 pH
Sensor Slope : 100.0 %
Primary Buffer : pH6.88
Secondary Buffers : pH4.00 & pH9.22
Control Limit : 6.5 pH
Control Direction : Add if High
Control Sensitivity : Medium
Control ON Time : 5 Minutes
Control OFF Time : 10 Minutes
ShutOFF Timer : 15 Minutes
Quick-Dose Time : 5 Minutes

Temperature

Sensor Offset : 0.0 °C

RS232 Port (when the Plus-Pack is fitted)

RS232 Baud Rate : 9600 Baud (applicable when the Plus-Pack is fitted)

22. Instrument firmware version number

If you need to phone or fax TPS for any further technical assistance, the version number of your **hydroCHEM** firmware may of benefit to us. The version number is displayed by the **hydroCHEM** at turn-on.

23. Troubleshooting

23.1 General Errors

Error Message	Possible Causes	Remedy
Factory Calibration Data Failure Temperature Readings may be Inaccurate	The EEPROM chip which contains the factory calibration information has failed.	The unit must be returned to TPS for service. <ul style="list-style-type: none"> • Temperature readings may be up to 10% incorrect. • Conductivity/TDS readings will be accurate after 2 point calibration.
EEPROM Write Failure Return to Factory for Service	User calibration settings have been lost or corrupted.	Switch the meter OFF and switch back ON. If the problem persists, return the unit to TPS for service.
Logged Data pointer failure All Logged Data Lost	<ol style="list-style-type: none"> 1. Memory back-up battery has lost its charge due to lack of use of the instrument. 2. Memory back-up battery is faulty. 	<p>Recharge the memory back-up battery by switching the meter on for approx. 16 hours (this does not need to be continuous).</p> <p>Return the instrument to the factory to have a new rechargeable battery fitted.</p>
"NoFl o" message does not appear, even when the Conductivity sensor is dry and in air	<ol style="list-style-type: none"> 1. Sensor has a build-up of salts or algae between wires. 2. Sensor is faulty. 	<p>Clean probe as per section 24.2.2.</p> <p>Return sensor to factory for repair or replacement.</p>
"NoFl o" message appears even when the Conductivity sensor is in solution.	<ol style="list-style-type: none"> 1. Conductivity of solution is below 0.5 mS/cm (0.2 ppK TDS). 2. Sensor is faulty. 	<p>The flow sensing function only operates if the Conductivity is above 0.5 mS/cm (0.2 ppK TDS).</p> <p>If a fresh batch of water is being used, use the Quick-Dose function (section 4) to raise the Conductivity to above 0.5 mS/cm.</p> <p>An optional pump detector is available to solve this problem automatically. Please contact the factory or your distributor.</p> <p>Return sensor to factory for repair or replacement.</p>

23.2 Conductivity / TDS Troubleshooting

Symptom	Possible Causes	Remedy
Unit fails to calibrate, even with new probe.	Calibration settings outside of allowable limits due to previous failed calibration.	Reset the unit. See section 21.
Unit attempts Span calibration instead of Zero calibration.	Sensor has Zero error.	Thoroughly rinse sensor in distilled water and allow to completely dry in air before attempting zero calibration. If instrument does not calibrate at Zero with sensor disconnected, then the instrument is faulty.
Standard calibration fails, and span is less than 75%.	<ol style="list-style-type: none"> Sensor is not immersed correctly. Sensor may have a build-up of dirt or oily material on electrode wires. Standard solution is inaccurate. Sensor is faulty. Faulty instrument. 	<p>Immerse sensor correctly, at least to the top of the large vent hole, as per diagram in section 7.1.</p> <p>Clean sensor, as per the instructions detailed in section 24.2.2.</p> <p>Replace standard solution.</p> <p>Return sensor to factory for repair or replacement.</p> <p>Return to factory for repair.</p>
Standard calibration fails, and span is greater than 133%.	<ol style="list-style-type: none"> Standard solution is inaccurate. Sensor may have a build-up of conductive material, such as salt. Sensor is faulty. Faulty instrument. 	<p>Replace standard solution.</p> <p>Clean sensor, as per the instructions detailed in section 24.2.2.</p> <p>Return sensor to factory for repair or replacement.</p> <p>Return to factory for repair.</p>
Inaccurate readings, even when calibration is successful.	<ol style="list-style-type: none"> Sensor may have a build-up of dirt or oily material on electrode wires. 	Clean sensor, as per the instructions detailed in section 24.2.2.
Readings drift.	<ol style="list-style-type: none"> Sensor may have a build-up of dirt or oily material on electrode wires. 	Clean sensor, as per the instructions detailed in section 24.2.2.
Readings are low or near zero.	<ol style="list-style-type: none"> Sensor may have a build-up of dirt or oily material on electrode wires. Sensor is not immersed correctly. Sensor is faulty. Faulty instrument. 	<p>Clean sensor, as per the instructions detailed in section 24.2.2.</p> <p>Immerse sensor correctly, at least to the top of the large vent hole, as per diagram in section 7.1.</p> <p>Return sensor to factory for repair or replacement.</p> <p>Return to factory for repair.</p>

23.3 pH Troubleshooting

Symptom	Possible Causes	Remedy
Unit fails to calibrate, even with new probe.	Calibration settings outside of allowable limits due to previous failed calibration.	Reset the unit. See section 21.
1 Point calibration fails (Asymmetry is greater than +/-1.00 pH).	1. Reference junction blocked.	Clean reference junction, as per instructions supplied with the electrode.
2 Point calibration fails (Slope is less than 85.0%).	1. Buffer set incorrectly 2. Glass bulb not clean. 3. Electrode is aged. 4. Connector is damp. 5. Buffers are inaccurate.	For automatic buffer recognition, ensure that you are using buffers that match the selected buffer set (section 20). Clean glass bulb as per instructions supplied with the electrode. Attempt rejuvenation, as per instructions supplied with the electrode. If not successful, replace electrode. Dry in a warm place. Replace buffers.
Unstable readings.	1. Reference junction blocked. 2. Glass bulb not clean. 3. Bubble in glass bulb. 4. Faulty connection to meter. 5. Reference junction not immersed.	Clean reference junction, as per instructions supplied with the electrode. Clean glass bulb as per instructions supplied with the electrode. Flick the electrode to remove bubble. Check connectors. Replace if necessary. Ensure that the bulb AND the reference junction are fully immersed, as per diagram in section 9.1.
Inaccurate readings, even when calibration is successful.	Reference junction blocked.	Clean reference junction, as per instructions supplied with the electrode.
Displays 7.00 for all solutions.	Electrical short in connector.	1. Check connector. Replace if necessary. 2. Replace electrode.
Displays 4-5 pH for all solutions.	Glass bulb or internal stem cracked.	Replace electrode.

23.4 Temperature Troubleshooting

Symptom	Possible Causes	Remedy
Temperature inaccurate and cannot be calibrated.	1. Faulty connector. 2. Faulty temperature sensor (inside Conductivity sensor).	Check the connector and replace if necessary. Fit new Conductivity/Temperature sensor.
Displays flashing “OVR ^o c” when temperature probe plugged in.	1. Faulty Cond/Temp socket. 2. Faulty temperature sensor (inside Conductivity sensor).	Return the instrument to the TPS factory for service. Fit new Conductivity/Temperature.

24. Appendices

24.1 Mounting the hydroCHEM

24.1.1 Mounting the hydroCHEM enclosure (when not fitted onto a mounting panel)

The **hydroCHEM** enclosure has three mounting points. The dimensions for the centres of these points are written on the rear of the enclosure. The single large bracket is hooked over a screw with a large head. The two bottom mounting points are accessed by removing the bottom cover of the enclosure. A drilling template for mounting the **hydroCHEM** enclosure is provided on the last page of this manual. This page can be removed or copied.

24.1.2 Mounting the hydroCHEM Dosing System panel.

The **hydroCHEM** Dosing System is pre-installed onto a single, convenient mounting panel. 6mm diameter holes are located in each corner for mounting the panel. Use fasteners that are suitable for material to which the panel is being mounted. The fasteners should be rated to at least 1.5kg each.

24.2 Care and Cleaning of Conductivity Sensors

24.2.1 Care of Conductivity sensors

The conductivity section of the sensor supplied with your **hydroCHEM** consists of four platinum wires wound around a central stem. The stainless steel tip is purely for temperature measurement.

Although the four wire system is extremely resistant to fouling, avoid contact with oily materials and excessive algae build-up. If a coating is allowed to form on the surface of the wires, accuracy will be reduced.

Conductivity sensors can be stored dry. Ensure that the sensor is stored in a covered container to avoid dust and dirt build-up.

24.2.2 Cleaning of Conductivity of Sensors.

Four wire Conductivity sensors can be cleaned by wiping the wires with a clean, soft cloth. Methylated Spirits or detergents may be used on the cloth to remove any build-up.

Stubborn contamination can be removed by soaking the sensor in a solution of 1 part Concentrated HCl and 10 parts distilled water. Approximately 5 minutes soaking should remove most build-ups. Avoid prolonged exposure to the acid, as the stainless steel tip may deteriorate.

If these methods fail, then the last resort is to physically scrub the electrode wires to remove the contaminant. Use only a cloth or nylon scouring pad. **DO NOT USE STEEL WOOL.**

24.3 pH Electrode Fundamentals

A combination pH Electrode is two electrodes in one. The sensing membrane is the round or spear shaped bulb at the tip of the electrode. This produces a voltage that changes with the pH of the solution. This voltage is measured with respect to the second part of the electrode, the reference section. The reference section makes contact with the sample solution using a salt bridge, which is referred to as the reference junction. A saturated solution of KCl is used to make contact with the sample. It is vital that the KCl solution has an adequate flow rate in order to obtain stable and accurate pH measurements.

24.3.1 Asymmetry of a pH Electrode

An “ideal” pH electrode produces 0 mV output at 7.00 pH. In practice, pH electrodes generally produce 0 mV output at slightly above or below 7.00 pH. The amount of variance from 7.00 pH is called the asymmetry. Figure 24-1 illustrates how asymmetry is expressed.

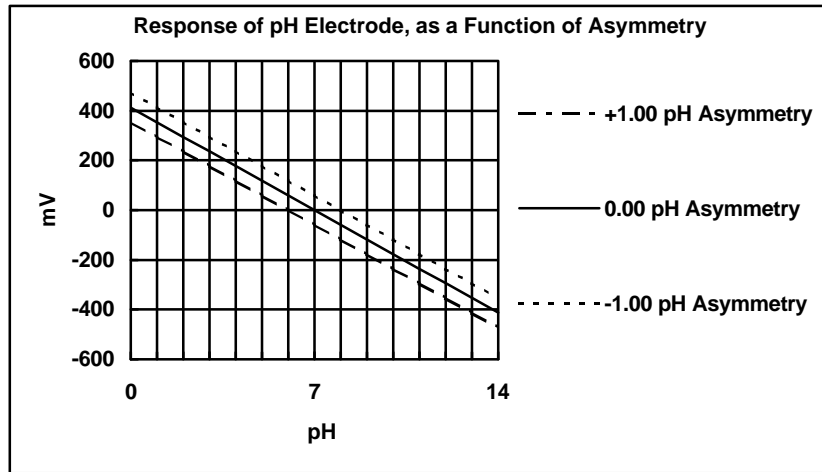

Figure 24-1

24.3.2 Slope of a pH Electrode

As mentioned above, a pH electrode produces 0 mV output at around 7.00 pH. As the pH goes up, an “ideal” pH electrode produces -59mV/pH unit at 25 °C. As the pH goes down, an ideal pH electrode produces +59mV/pH unit. In practice, pH electrodes usually produce slightly less than this. The output of a pH electrode is expressed as a percentage of an ideal electrode. For example, an ideal electrode that produces 59mV/pH unit has “100% Slope”. An electrode that produces 50.15mV/pH unit has “85% Slope” (see Figure 24-2).

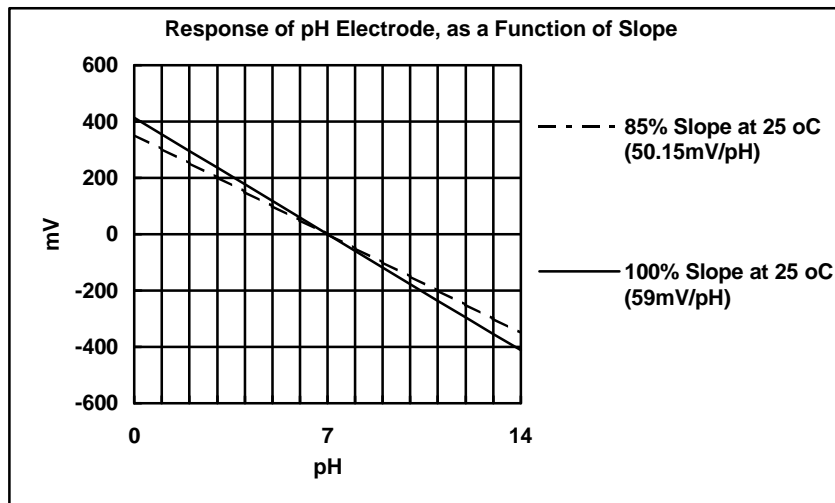

Figure 24-2

24.3.3 Temperature Compensation

The slope of a pH electrode is affected by temperature. This effect is compensated for either by using an Automatic Temperature Compensation (ATC) probe or by entering the sample temperature manually. Figure 24-3 shows the slope of a pH electrode at various temperatures.

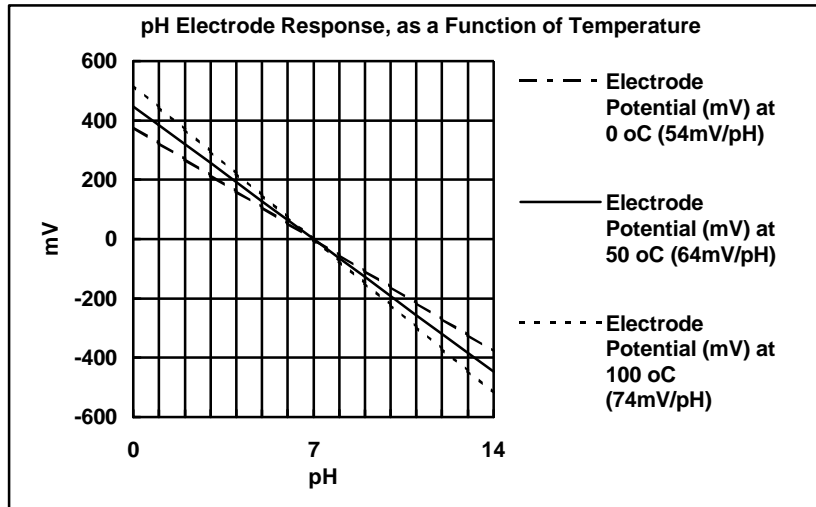

Figure 24-3

24.4 hydroCHEM Specifications

	Standard Unit		With optional Plus-Pack fitted		Accuracy
	Range	Resolution	Range	Resolution	
pH	0 to 14.0 pH	0.1 pH	0 to 14.00 pH	0.1 & 0.01 pH	±0.01 pH
Conductivity	0 to 9.9 mS/cm	0.1 mS/cm	0 to 9.99 mS/cm	0.1 & 0.01 mS/cm	±0.5%
	0 to 99 CF Unit	1 CF Unit	0 to 99.9 CF Units	1 & 0.1 CF Units	±0.5%
	0 to 9.9 dS/m	0.1 dS/m	0 to 9.99 dS/m	0.1 & 0.01 dS/m	±0.5%
TDS	0 to 9.9 ppK	0.1 ppK	0 to 9.99 ppK	0.01 ppK	±1.0%
Temperature	-10.0 to 120.0 °C	0.1 °C	-10.0 to 120.0 °C	0.1 °C	±0.2 °C

Calibration

Automatic Calibration for all parameters, within the following limits...

Conductivity Zero Range : 0 to 0.2 mS/cm, 0 to 2 CF Units or 0 to 0.2 dS/m, depending on which mode is selected.

Conductivity Span Range : 75 to 133 %

Conductivity Standards : Automatic recognition of 2.76mS/cm or 1.41 mS/cm standard

TDS Zero Range : 0 to 0.1 ppK

TDS Span Range : 75 to 133 %

TDS Standard : Automatic recognition of 2.0 ppK standard

pH Asymmetry Range : -1.00 to +1.00 pH

pH Slope Range : 85.0 to 105 %

pH Buffers : Automatic recognition of pH4.00, pH6.88, pH7.00, pH9.23 and pH10.06 buffers. See section 20 for details on selecting buffers.

Temperature Offset Range : -10.0 °C to +10.0 °C

Control Set-up

		pH	Conductivity	TDS	
Standard Unit	Limit Range	0 to 14.0 pH	0 to 9.9 mS/cm	0 to 9.9 ppK	
	Sensitivity	Fine	0.1 pH	0.1 mS/cm	0.05 ppK
		Medium	0.2 pH	0.2 mS/cm	0.1 ppK
		Coarse	0.3 pH	0.3 mS/cm	0.15 ppK
With optional Plus-Pack fitted	Limit Range	0 to 14.00 pH	0 to 9.99 mS/cm	0 to 9.99 ppK	
	Sensitivity	Fine	0.10 pH	0.10 mS/cm	0.05 ppK
		Medium	0.20 pH	0.20 mS/cm	0.10 ppK
		Coarse	0.30 pH	0.30 mS/cm	0.15 ppK
Dosing ON Timer Range	Note: Enter 0 minutes to take pump off line	0 to 30 minutes	0 to 30 minutes	0 to 30 minutes	
Dosing OFF Timer range	Note: Enter 0 minutes for untimed control (ie. add on demand)	0 to 30 minutes	0 to 30 minutes	0 to 30 minutes	
ShutOFF Timer Range		5 to 240 minutes	10 to 240 minutes	10 to 240 minutes	
Quick-Dose Timer Range		0 to 10 minutes	0 to 10 minutes	0 to 10 minutes	

Good Laboratory Practices

- All calibration information and user-adjustable set-up information is stored in memory, and can be recalled on the display at any time. This information can also be printed or downloaded to a computer, when the optional Plus Pack is fitted.
- The unit's serial number is stored in memory. This is displayed at turn-on, and included with GLP information.

Plus Pack Option

The Plus Pack option includes the following items...

- RS232 Serial Interface for printing or downloading data.
- Datalogging capability.
- 24 Hour Calendar Clock.
- Selectable High or Low resolution.

Datalogging

This section is applicable when the optional Plus-Pack is fitted.

Memory	: 2300 readings, including date and time.
Automatic Datalogging	: User selectable for one reading every... 1, 2, 5, 10, 15, 20 or 30 minutes, or every... 1, 2, 3, 4, 6, 8, 12 or 24 hours.

RS232 Serial Interface

This section is applicable when the optional Plus-Pack is fitted.

Port Configuration	: 8 Bits, No Parity, 1 Stop Bit, XON/XOFF Protocol.
Baud Rates	: User selectable for 300, 1200, or 9600 Baud.

Calendar Clock

This section is applicable when the optional Plus-Pack is fitted.

- 24 Hour Calendar Clock.
- Tests for valid day of the month when setting (eg. 31/09/99 is not valid).
- Adjusts for leap years.
- The microprocessor in the **hydroCHEM** stores the year to 2 digits. However, all data sent to the RS232 port is converted to 4 digits, so there are no Year 2000 problems.

Peristaltic Pumps

*This section is applicable to the **hydroCHEM-DS** and the **hydroCHEM-P**.*

- 2 x built-in 5 Litre/ Hour Peristaltic Pumps.
- Dual Tube pump adds A & B Nutrient in 1:1 ratio to within 3%.
- Chemical resistant Viton pump tubing, 6mm O.D. x 4mm I.D.

25. Warranty

TPS Pty. Ltd. guarantees all instruments and sensors to be free from defects in material and workmanship when subjected to normal use and service. This guarantee is expressly limited to the servicing and/or adjustment of an instrument returned to the Factory, or Authorised Service Station, freight prepaid, within twelve (12) months from the date of delivery, and to the repairing, replacing, or adjusting of parts which upon inspection are found to be defective. Warranty period on sensors is three (3) months.

There are no express or implied warranties which extend beyond the face hereof, and TPS Pty. Ltd. is not liable for any incidental or consequential damages arising from the use or misuse of this equipment, or from interpretation of information derived from the equipment.

Shipping damage is not covered by this warranty.

PLEASE NOTE

A guarantee card is packed with the instrument or sensor. This card must be completed at the time of purchase and the registration section returned to TPS Pty. Ltd. within 7 days. No claims will be recognised without the original guarantee card or other proof of purchase. This warranty becomes invalid if modifications or repairs are attempted by unauthorised persons, or the serial number is missing.

PROCEDURE FOR SERVICE

If you feel that this equipment is in need of repair, please re-read the manual. Sometimes, instruments are received for "repair" in perfect working order. This can occur where the sensor(s) simply requires cleaning or replacement or some other field serviceable event.

TPS Pty. Ltd. has a fine reputation for prompt and efficient service. In just a few days, our factory service engineers and technicians will examine and repair your equipment to your full satisfaction.

To obtain this service, please follow this procedure...

Return the instrument AND ALL SENSORS to TPS freight pre-paid and insured in its original packing or suitable equivalent. INSIST on a proof of delivery receipt from the carrier for your protection in the case of shipping claims for transit loss or damage. It is your responsibility as the sender to ensure that TPS receives the unit.

Please check that the following is enclosed with your equipment:

- **Your Name and daytime phone number.**
- **Your company name, ORDER number, and return street address.**
- **A description of the fault. (Please be SPECIFIC.)**
(Note: "Please Repair" does NOT describe a fault.)

Your equipment will be repaired and returned to you by air express where possible.

For out-of-warranty units, a repair cost will be calculated from parts and labour costs. If payment is not received for the additional charges within 30 days, or if you decline to have the equipment repaired, the complete unit will be returned to you freight paid, not repaired. For full-account customers, the repair charges will be debited to your account.

Drilling template for **hydroCHEM** enclosure (when not mounted onto Dosing System panel)

