

Congratulations !

You have purchased the latest in Handheld Specific Ion-pH-mV-Temperature instrumentation. We trust that your new **WP-90** will give you many years of reliable service.

The **WP-90** is a breeze to operate. This manual has been designed to help you get started, and also contains some handy application tips. If at any stage you require assistance, please contact either your local TPS representative or the TPS factory in Brisbane.

The manual is divided into the following sections:

1. Table of Contents

Each major section of the handbook is clearly listed. Sub-sections have also been included to enable you to find the information you need at a glance.

2. Introduction

The introduction has a diagram and explanation of the display and controls of the **WP-90**. It also contains a full listing of all of the items that you should have received with your **WP-90**. Please take the time to read this section, as it explains some of items that are mentioned in subsequent sections.

3. Main Section

The main section of the handbook provides complete details of the **WP-90**, including operating modes, calibration, troubleshooting, specifications, and warranty terms.

4. Appendices

Appendices containing background information and application notes are provided at the back of this manual.

**Model WP-90
Specific Ion, pH,
mV, & Temp. Meter**

Handbook Version: 1.3

Date: 30-Aug-05

Author: AB



TPS Pty Ltd

4 Jamberoo Street
Springwood, Brisbane,
Australia, 4127

Phone : (07) 32 900 400

International : 61 7 32 900 400

Fax : (07) 3808 4871

International : 61 7 3808 4871

E-mail : tps@tps.com.au

Web Site : www.tps.com.au

Contents

1. Introduction	5
1.1 WP-90 Display and Controls.....	5
1.2 Unpacking Information.....	7
1.3 Specifications.....	8
2. WP-90 Menu Structure	10
3. Specific Ion Mode.....	12
3.1 Selecting ppM or ppK Mode	12
3.2 Selecting Exponential Mode (e.g. Molar).....	14
4. Specific Ion Calibration	16
4.1 Calibration Procedure	16
4.2 Calibration Notes	18
4.3 Calibration Messages	18
5. pH Calibration.....	20
5.1 Calibration Procedure	20
5.2 Calibration Notes	21
5.3 Calibration Messages	21
6. mV Calibration.....	23
7. Relative mV Calibration	23
7.1 Notes.....	23
8. Temperature Calibration.....	24
8.1 Calibration Procedure	24
8.2 Calibration Notes	25
8.3 Calibration Messages	25
8.4 Manual Temperature Setting	25
9. Good Laboratory Practices (GLP)	26
9.1 To recall GLP information on the display.....	26
9.2 Failed Calibration.....	28
9.3 Printing GLP Information to the RS232 Port.....	28
9.4 Instrument Serial Number.....	29
9.5 Additional GLP Features.....	29

10. Notepad Function	30
10.1 Recording Readings into the Notepad	30
10.2 Recalling Records from the Notepad	30
10.3 Erasing Records from the Notepad	31
10.4 Printing Records from the Notepad to the RS232 Port	31
11. Automatic Datalogging	32
12. RS232 Port	34
12.1 Setting the Baud Rate	34
12.2 Sending Readings to the RS232 Port	34
12.3 RS232 Configuration	34
12.4 Communication and Statistical Software	34
12.5 Commands	35
12.6 Data Format	36
12.7 GLP Data Format	37
13. Battery Saver Function	38
14. Recharging the Battery	39
15. Clock Function	40
15.1 Setting the Clock	40
15.2 Displaying or Hiding the Clock	40
16. Selecting Buffers for Auto Buffer Recognition	41
17. Initialising the WP-90	42
18. Instrument firmware version number	42
19. Troubleshooting	43
19.1 General Errors	43
19.2 Specific Ion, pH and mV Troubleshooting	44
19.3 Temperature Troubleshooting	46
20. pH Sensor Fundamentals	47
20.1 Asymmetry of a pH Sensor	47
20.2 Slope of a pH Sensor	48
20.3 pH Temperature Compensation	49
20.4 Checking the reference junction of a pH sensor	49
20.5 Determining if a pH meter or a sensor is faulty	50
21. Warranty	51

1. Introduction

1.1 WP-90 Display and Controls

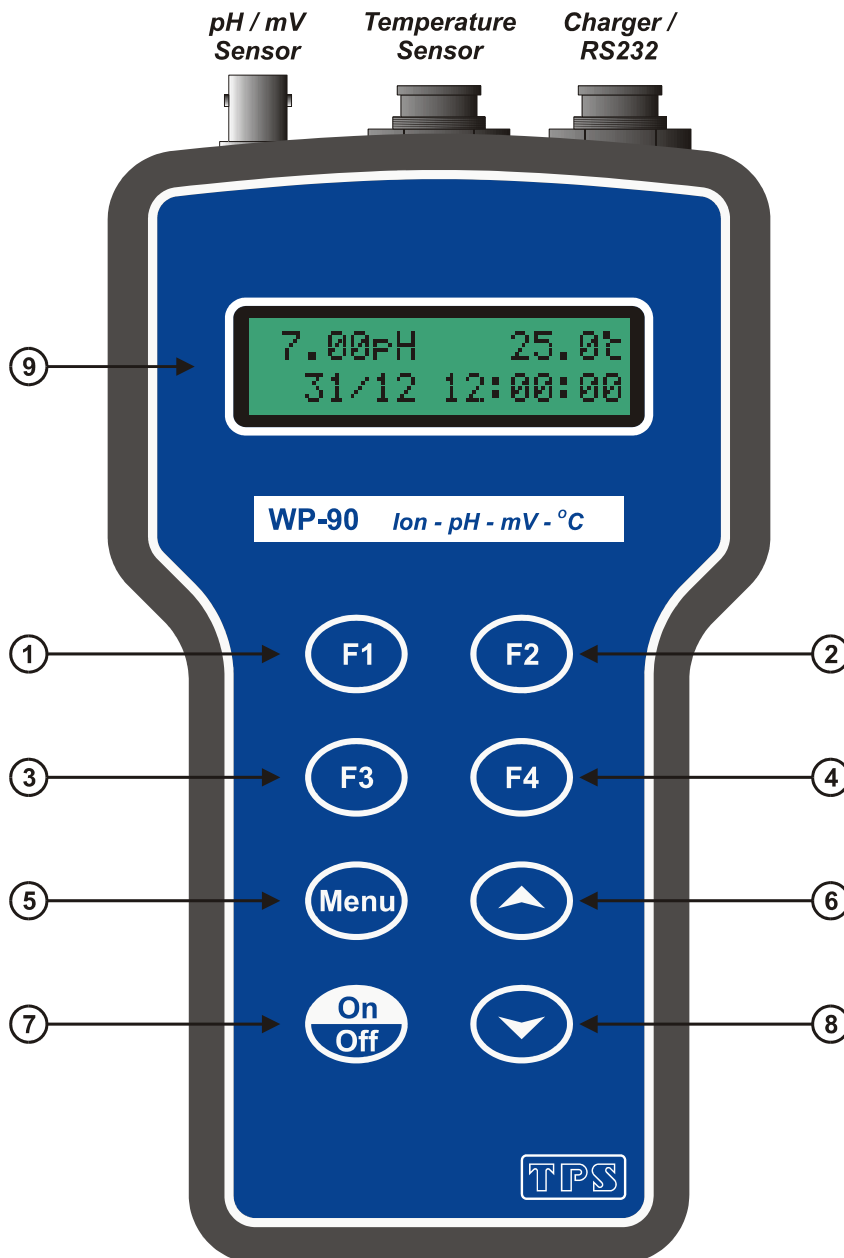



Press to record readings into memory. See section 10.1.

Also used at turn-on to select pH6.88 or pH7.00 as the primary pH buffer (section 16).



Press to show or hide the date and time. See section 15.2.



Press to start or stop automatic logging. See section 11.

Alternatively, press to transmit current reading plus date and time to the RS232 port. See section 12.2.





Press to zero Relative mV, when Relative mV mode is selected (section 7).



Press to access the user-friendly menu system which makes the **WP-90** easy to operate.



The  and  keys are used for calibrating temperature readout (section 8.1), setting the clock (section 15.1), setting the automatic logging period (section 11), and displaying GLP information (section 9.1).

The  key is also used to initialise the **WP-90** at turn-on. See section 17.



Switches the **WP-90** on and off.

⑨ **Display** 32 character alpha-numeric display with user-friendly menu and prompting system. Shows Specific Ion/pH/mV and Temperature simultaneously. Date and time can also be displayed.

1.2 Unpacking Information

Before using your new **WP-90**, please check that the following accessories have been included...

	Part No
WP-90 Specific Ion-pH-mV-Temp Instrument.....	121191
Temperature/ATC Sensor.....	121247
Battery charger	130037
WP-90 Handbook	130050

Options that may have been ordered with your WP-90...

RS232 Serial Interface Cable	130041
Communication software for Windows 3.1, 95 & NT ..	130086
USB to Serial Adaptor (requires 130041 also).....	130087
Hard Carry Case.....	130059
Battery charger lead for 12V cigarette lighter socket.	130046
Solar Panel	130012
RS232 Printer	130031

Sensors...

Your choice of a complete range of Ion Selective, Reference, pH and Redox sensors.

Other spares...

1. 6V NiCad Battery	130038
---------------------------	--------

1.3 Specifications

Mode	Ranges	Resolution	Accuracy
Specific Ions	Auto-ranging, in units of ppM, ppK and Exponential Notation	3 significant digits	± least significant digit
Ph	0 to 14.00 pH	0.01 pH	±0.01 pH
mV & Relative mV	0 to +/-500.0 mV 0 to ±1500 mV	0.15 mV 1 mV	±0.3 mV ±1 mV
Temperature	-10.0 to 120.0 °C	±0.1 °C	±0.2 °C

Specific Ion Specifications

Input Impedance	: >3 x 10 ¹² Ω
Asymmetry Range	: Auto detection
Slope Range	: 50.0 to 110.0 %
Temperature Compensation	: Automatic, 0 to 100 °C
Calibration	: Automatic calibration in user-definable standards.

pH Specifications

Input Impedance	: >3 x 10 ¹² Ω
Asymmetry Range	: -1.00 to 1.00 pH
Slope Range	: 85.0 to 105.0 %
Temperature Compensation	: Automatic, 0 to 100 °C
Calibration	: Automatic calibration in pH4.00, pH6.88, pH7.00, pH9.23 or pH10.00 buffers.

Temperature Specifications

Temp. Sensor Offset Range	: -10.0°C to +10.0°C
---------------------------	----------------------

General Specifications

Memory	: 2400 readings including date and time
Automatic Logging	: User-set for one reading every 1 to 90 seconds, minutes or hours.
RS232 Output	: 300, 1200, 9600 & 19200 baud. 8 bits, no parity, 1 stop bit, XON/XOFF Protocol.
Clock	: Calendar clock displays date, month, hours, minutes & seconds. Year is recorded in memory and transmitted to the RS232 port, but is not displayed.
Battery Saver	: On : Auto switch-off after 5 minutes Off : Continuous use Bar Graph display of battery charge level. Readout of battery voltage available for troubleshooting.
Good Laboratory Practices	: Date, Time and results of last Specific Ion, pH and Temperature calibration are stored in memory. This information can be recalled or sent to the RS232 port at any time.
Power	: 6V NiMH Rechargeable Battery for approx 75 hours operation.
Dimensions	: 187 x 110 x 51 mm
Mass	: Instrument only : Approx 440g Full Kit : Approx 2.0 kg
Environment	: Temperature : 0 to 45 °C Humidity : 0 to 90 % R.H.

2. WP-90 Menu Structure

A detailed breakdown of the menu system of the **WP-90** is shown below. This diagram provides a quick reference for the menu functions available for the **WP-90**.

Press the function keys in normal display mode, to perform the following tasks:

- ⓕ1 : Press to record current data plus date and time into memory.
- ⓕ2 : Press to show or hide date and time.
- ⓕ3 : Press to start and stop automatic logging.
If logging period is set to zero, press to transmit current reading plus date and time to the RS232 port.
- ⓕ4 : Press to zero Relative mV, when Relative mV mode is selected.
- Ⓜ : Press to access the user-friendly menu system, as detailed over the page.

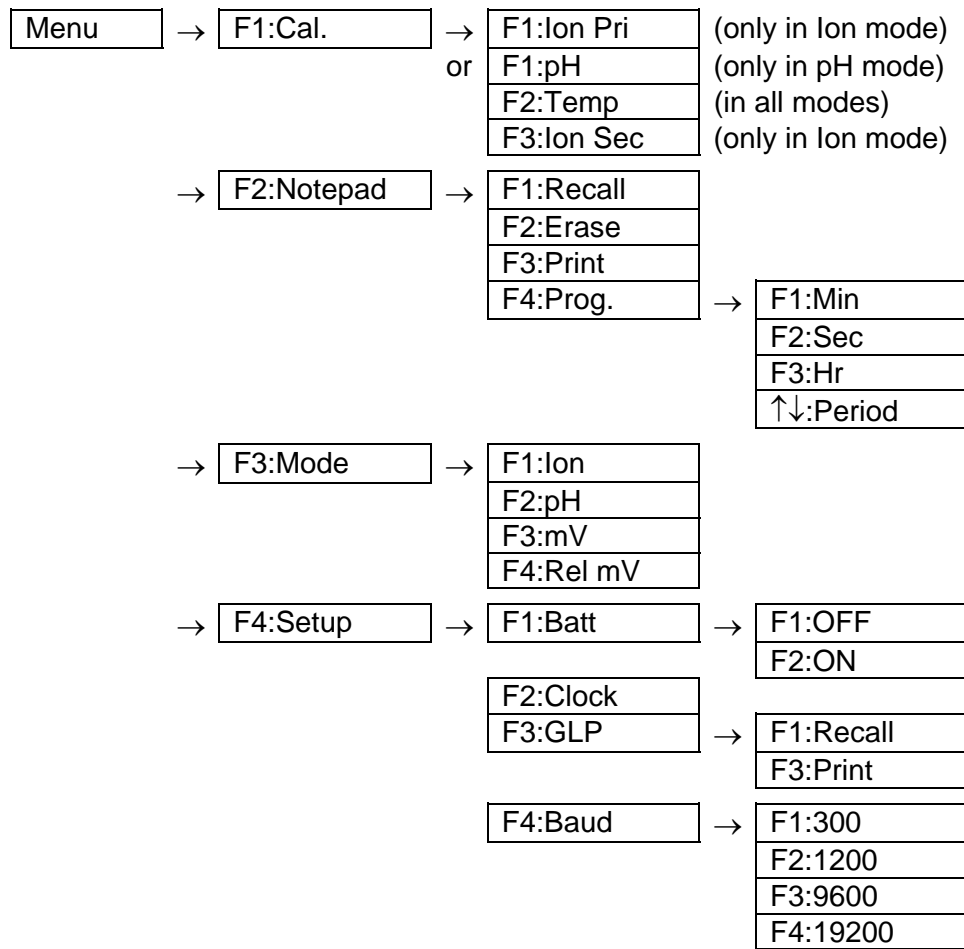
WP-90 Menu Structure

3. Specific Ion Mode

Before taking Specific Ion measurements, it is necessary to set up this mode for the Specific Ion to be measured. To set up the Specific Ion mode, follow these simple steps...

3.1 Selecting ppM or ppK Mode

1. Select Specific Ion mode (Menu → **F3:Mode** → **F1:Ion**).
2. Select ppM/ppK as the unit of measurement.



Select Ion Mode
F1:ppM/ppK F2:Exp

Press **F1** to select readout in ppM (parts per million) and ppK (parts per thousand). The **WP-90** will automatically select the range that provides the best resolution for the sample being measured.

3. Select the type of Specific Ion to be measured.

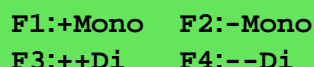

F1:+Mono F2:-Mono
F3:++Di F4:--Di

Press **F1** for Monovalent Cation (e.g. Na⁺).

Press **F2** for Monovalent Anion (e.g. F⁻).

Press **F3** for Divalent Cation (e.g. Cu²⁺).

Press **F4** for Divalent Anion (e.g. S²⁻).

4. Enter the value of the Primary Standard to be used for calibration.

```

1.000ppM Pri Std
F1:← F2:→ ↑↓:Set

```

Use the \uparrow and \downarrow keys to set the first digit. The numbers scroll from 0 to 9 plus the decimal point.

Press $F2$ to move to the next digit, then use the \uparrow and \downarrow keys to set it. Continue moving from digit to digit until the value of the Primary Standard has been correctly set. Up to 4 digits plus a decimal point can be entered.

After the last digit has been entered, $F2$ will move the cursor to the units.

Use the \uparrow and \downarrow keys to select ppM or ppK.

Press $F2$ to save the Primary Standard.

5. Enter the value of the Secondary Standard to be used for calibration.
The Secondary Standard must be at least 2 to 100 times higher or lower than the Primary Standard.

```

10.00ppM Sec Std
F1:← F2:→ ↑↓:Set

```

Use the \uparrow and \downarrow keys to set the first digit. The numbers scroll from 0 to 9 plus the decimal point.

Press $F2$ to move to the next digit, then use the \uparrow and \downarrow keys to set it. Continue moving from digit to digit until the value of the Secondary Standard has been correctly set.

Up to 4 digits plus a decimal point can be entered.

After the last digit has been entered, $F2$ will move the cursor to the units.

Use the \uparrow and \downarrow keys to select ppM or ppK.

Press $F2$ to save the Secondary Standard.

6. The **WP-90** will now return to normal measurement mode.
7. A “ * ” will be shown in place of the decimal point if the Specific Ion mode is not calibrated, or if calibration has failed.

3.2 Selecting Exponential Mode (e.g. Molar)

1. Select Specific Ion mode (Menu) → **F3:Mode** → **F1:Ion**.
2. Select Exponential mode as the unit of measurement. This mode is designed specifically for units such as Molar.

```
Select Ion Mode
F1:ppM/ppK  F2:Exp
```

Press **F2** to select Exponential readout (e.g. Molar). The **WP-90** will automatically select the range that provides the best resolution for the sample being measured.

3. Select the type of Specific Ion to be measured.

```
F1:+Mono  F2:-Mono
F3:++Di   F4:--Di
```

Press **F1** for Monovalent Cation (e.g. Na⁺).

Press **F2** for Monovalent Anion (e.g. F⁻).

Press **F3** for Divalent Cation (e.g. Cu²⁺).

Press **F4** for Divalent Anion (e.g. S²⁻).

4. Enter the value of the Primary Standard to be used for calibration.

```
1.0010+00 Pri Std
F1:← F2:→ ↑↓:Set
```

Use the **▲** and **▼** keys to set the first digit. The numbers scroll from 0 to 9.

Press **F2** to move to the next 2 digits, then use the **▲** and **▼** keys to set each in turn (the decimal point is fixed in the second position).

Press **F2** to move the 10⁺, then use the **▲** and **▼** keys to set it as 10⁺ or 10⁻.

Press **F2** to move to the next 2 digits, then use the **▲** and **▼** keys to set each in turn.

For example...

1.0010⁺⁰¹ is 1.00×10^1 in units of the operator's choice (e.g. Molar).

1.0010⁻⁰¹ is 1.00×10^{-1} in units of the operator's choice (e.g. Molar).

Press **F2** to save the Primary Standard.

5. Enter the value of the Secondary Standard to be used for calibration.
The Secondary Standard must be at least 2 to 100 times higher or lower than the Primary Standard.

```

1.0010+00 Sec Std
F1:← F2:→ ↑↓:Set
  
```

Use the **▲** and **▼** keys to set the first digit. The numbers scroll from 0 to 9.

Press **F2** to move to the next 2 digits, then use the **▲** and **▼** keys to set each in turn (the decimal point is fixed in the second position).

Press **F2** to move the 10^+ , then use the **▲** and **▼** keys to set it as 10^+ or 10^- .

Press **F2** to move to the next 2 digits, then use the **▲** and **▼** keys to set each in turn.

For example...

1.0010⁺⁰¹ is 1.00×10^1 in units of the operator's choice (e.g. Molar).

1.0010⁻⁰¹ is 1.00×10^{-1} in units of the operator's choice (e.g. Molar).

Press **F2** to save the Secondary Standard.

6. The **WP-90** will now return to normal measurement mode.
7. A “ * ” will be shown in place of the decimal point if the Specific Ion mode is not calibrated, or if calibration has failed.

4. Specific Ion Calibration

4.1 Calibration Procedure

1. Plug the Ion Selective Electrode into the **Sensor** socket. If a separate Reference Electrode is being used, plug this into the separate 4mm Reference socket provided.

2. Switch the meter on.

3. Select and set up Ion mode, as detailed in section 3.

For the purposes of this handbook, the **WP-90** has been set up for 1.000ppM as the Primary Standard and 0.100ppM as the Secondary Standard.

4. Ensure that temperature has already been calibrated (see section 8.1).

NOTE: A “ * ” in place of the decimal point in the temperature readout indicates that temperature is not calibrated.

5. Rinse the Ion Selective, Reference and Temperature sensors in distilled water and blot dry.

Primary Calibration

6. Place the Ion Selective, Reference and Temperature sensors into the Primary Standard.

Ensure that any Ionic Strength Adjusting Buffer (ISAB) that may be required has been added (see the Ion Selective Electrode's handbook). A magnetic stirrer providing constant, gentle stirring generally improves stability.

7. Select Primary Calibration ( → **F1:Cal** → **F1:Ion Pri**).

The following message should be displayed. The current reading is displayed on the top left. A “*” in the reading indicates that the **WP-90** is currently not calibrated.

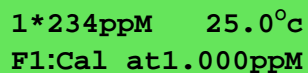

```
1*234ppM 25.0°C
F1:Cal at1.000ppM
```

When the reading has stabilised, press  to perform a Primary Calibration. A “*” will not be removed from the display after a 1-point Asymmetry Calibration.

- Rinse the Sensors in distilled water and blot dry.

Secondary Calibration

- Place the Ion Selective, Reference and Temperature sensors into the Secondary Standard.

Ensure that any Ionic Strength Adjusting Buffer (ISAB) that may be required has been added (see the Ion Selective Electrode's handbook).

A magnetic stirrer providing constant, gentle stirring generally improves stability.

- Select Secondary Calibration ( → **F1:Ca1** → **F3:Ion Sec**).

The following message should be displayed. The current reading is displayed on the top left. A "*" in the reading indicates that the **WP-90** is currently not calibrated.

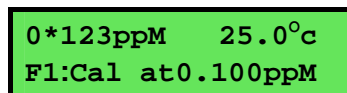

```
0*123ppM 25.0°C
F1:Ca1 at0.100ppM
```

When the reading has stabilised, press  to perform a Secondary Calibration.

A "*" in the display will be replaced by a decimal point after a successful 2-point Slope calibration.

- The WP-90 is now calibrated ready for Specific Ion measurements.

4.2 Calibration Notes

1. A Primary Calibration should be performed at least weekly. In applications where the reference electrode junction can become blocked, such as dairy products, mining slurries etc, a Primary Calibration may have to be done daily.
2. A full Primary and Secondary Calibration should be performed at least monthly. Of course, more frequent calibration will result in greater confidence in results.
3. All calibration information is retained in memory when the **WP-90** is switched off, even when the battery is removed. This information can be recalled or printed later using the GLP function (see section 9).
4. The **WP-90** displays the value of the standard to which it will attempt to calibrate. Ensure that the standard value displayed corresponds to the standard that you are using. Alter the set-up if necessary (see section 3)

4.3 Calibration Messages

1. If a Primary Calibration has been successfully performed, the **WP-90** will display the following message, and the offset value of the sensor. For example...

```
Primary Cal. OK  
Offset= 1.0mV
```

2. If a Secondary Calibration has been successfully performed, the **WP-90** will display the following message, and the slope value of the sensor. For example...

```
Sec Cal. OK  
Slope= 99.0%
```

3. If a Secondary Calibration has failed, the **WP-90** will display the following message, and the failed span value of the sensor. For example...





```
Sec Cal. Failed  
Slope= 49.0%
```

Notes

1. The Offset range is unlimited, as long as the reading is not over-ranged. This is to allow for the large variety of Ion Selective Electrodes available.
2. The allowable Slope range is 50.0% to 110.0%. This range is ample to allow for correctly functioning Ion Selective Electrodes.

5. pH Calibration

5.1 Calibration Procedure

1. Plug the pH sensor into the **Sensor** socket.
2. Switch the meter on.
3. Ensure that you are using buffers which have been selected for automatic buffer recognition. See section 16 for a detailed explanation.
4. Select pH Mode ( → **F3:Mode** → **F2:pH**).
5. Ensure that temperature has already been calibrated, or manually set (see sections 8.1 and 8.4). NOTE: If the decimal point in the temperature reading is shown by a *, then the temperature readout is not calibrated.
6. Remove the wetting cap from the pH sensor.
7. Rinse the pH and Temperature sensors in distilled water and blot them dry.
8. Ensure that you are using the primary buffer for which the **WP-90** has been set (see section 16).
Place both sensors into a small sample of pH6.88 (or pH7.00) buffer, so that the bulb and reference junction are both covered.
DO NOT place the sensors directly into the buffer bottle.
9. Select pH Calibration ( → **F1:Cal.** → **F1:pH**).
10. When the reading has stabilised, press the  key to calibrate. If a 1 point calibration has been performed, the * will not be removed until a full 2 point calibration has been performed.
11. Rinse the pH and Temperature sensors in distilled water and blot them dry.
12. Place both sensors into a small sample of pH4.00, pH9.23 or pH10.00 Buffer, so that the bulb and reference junction are both covered. **DO NOT** place the sensors directly into the buffer bottle.
NOTE: pH9.23 buffer is highly unstable. Avoid using this buffer if possible. Discard immediately after use.
13. Select pH Calibration ( → **F1:Cal.** → **F1:pH**).
14. When the reading has stabilised, press the  key to calibrate. The * will now be replaced by a decimal point, if calibration was successful.
15. The **WP-90** is now calibrated for pH and is ready for use. Discard the used samples of buffer.

5.2 Calibration Notes

1. A 1-point calibration should be performed at least weekly. In applications where the electrode junction can become blocked, such as dairy products, mining slurries etc, a 1-point calibration may have to be done daily.
2. A full 2-point calibration should be performed at least monthly. Of course, more frequent calibration will result in greater confidence in results.
3. All calibration information is retained in memory when the **WP-90** is switched off, even when the battery is removed. This information can be recalled or printed later using the GLP function (see section 9).
4. The **WP-90** displays the value of the pH buffer to which it will attempt to calibrate. Ensure that the buffer value displayed corresponds to the buffer that you are using.

5.3 Calibration Messages

1. If a 1-point Calibration has been successfully performed, the **WP-90** will display the following message, and the asymmetry value of the sensor. For example...

```
1 Point Cal.OK
Asy=0.10pH
```

2. If a 1-Point Calibration has failed, the **WP-90** will display the following message, and the failed asymmetry value of the sensor. For example...

```
1 Point Cal.Fail
Asy=1.50pH
```

3. If a 2-Point Calibration has been successfully performed, the **WP-90** will display the following message, and the asymmetry and slope values of the sensor. For example...

```
2 Point Cal.OK
Asy=0.10pH
```

then:

```
2 Point Cal.OK
Slope= 99.0%
```

4. If a Secondary Calibration has failed, the **WP-90** will display the following message, and the failed slope value of the sensor. For example...

```
2 Point Cal.Fail
Slope= 70.0%
```

or:

```
2 Point Cal.Fail
Slope=130.0%
```

Notes

1. The allowable Asymmetry range is -1.00pH to $+1.00\text{pH}$.
2. The allowable Slope range is 85.0% to 105.0% .

6. mV Calibration

The mV section is factory calibrated. There is no user-calibration facility for this mode.

7. Relative mV Calibration

Select Relative mV mode when measurements relative to a known standard are required. Calibration of the Relative mV mode is simply a matter of zeroing the reading when the sensor is in the known standard.

1. Plug the Redox sensor into the **Sensor** socket. Temperature compensation is not applied in Relative mV mode, so the temperature sensor does not need to be connected.
2. Switch the meter on.
3. Select Relative mV Mode ( → **F3:Mode** → **F4:Rel mV**).

The display should now be showing Relative mV on the top line with absolute mV or date and time on the bottom line. For example...

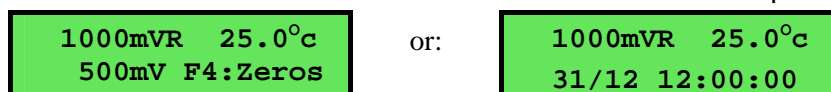

Press  to alternate between absolute mV or the clock on the bottom line.

4. Remove the wetting cap from the Redox sensor.
5. Rinse the sensor in distilled water and blot dry.
6. Place the Redox sensor into a sample of the known standard. Ensure that the platinum tip and reference junction are both covered.

When the reading has stabilised, press the  key to zero the Relative mV reading. The Relative mV reading will now be zero, and the absolute mV reading will remain unchanged. For example...

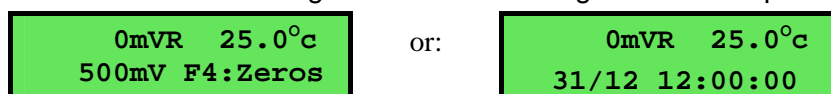

7. The **WP-90** Relative mV mode is now zeroed and is ready for use. The readout can be re-zeroed by pressing the  key whenever required.

7.1 Notes

1. The Relative mV offset is retained in memory when the **WP-90** is switched off, even when the battery is removed.
2. The Relative mV zero is reset when leaving Relative mV mode.

8. Temperature Calibration



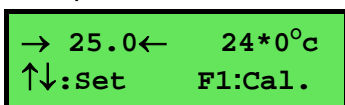

The temperature readout must be calibrated or manually set before attempting Specific Ion or pH calibration. The decimal point is replaced by a "*" if the reading is not calibrated.

8.1 Calibration Procedure

1. Plug the Temperature sensor into the **Temperature** socket.
2. Switch the meter on.
3. Place the sensor into a beaker of room temperature water, alongside a good quality mercury thermometer. Stir the sensor and the thermometer gently to ensure an even temperature throughout the beaker.
4. Select Temperature Calibration ( → **F1:Cal.** → **F2:Temp**).
5. The reading from the probe is now displayed on the right of the display, and the value you are going to set is shown on the left. A "*" in the reading indicates that the **WP-90** is currently not calibrated. For example...



```
→ 25.0←   24*0°C
↑↓:set     F1:Cal.
```

6. When the reading on the right has stabilised, press the  and  keys until the reading on the left shows the same temperature as the mercury thermometer.
7. Press the  key to calibrate the temperature readout.
The * will now be replaced by a decimal point, if calibration was successful.
Alternatively, press the  key to abort temperature calibration.
8. The **WP-90** is now calibrated for Temperature and is ready for use. The unit can now be calibrated for Specific Ions and pH.

8.2 Calibration Notes

1. Temperature calibration information is retained in memory when the **WP-90** is switched off, even when the battery is removed. This information can be recalled or printed later using the GLP function (see section 9).
2. Temperature does not need to be re-calibrated unless the sensor is replaced or the meter is initialised.

8.3 Calibration Messages

1. If a temperature calibration has been successfully performed, the **WP-90** will display the following message and the offset value of the probe.

```
Calibrate OK
Offset= 1.0°C
```

2. If a temperature calibration has failed, the **WP-90** will display the following message, and the failed offset value of the probe.





```
Calibrate Fail
Offset= 10.5°C
```

8.4 Manual Temperature Setting

If the temperature sensor is not connected, the temperature of the sample solution must be set manually for accurate Specific Ion and pH measurements. A separate thermometer will be required for this.

1. Switch the meter on.
2. Measure the temperature of the sample.
3. Select Temperature Calibration ( → **F1:Cal.** → **F2:Temp**)
4. The current temperature setting is now displayed. For example...

```
25.0← Man Temp
↑↓:Set    F1:Save
```

5. Press the  and  keys until the display shows the temperature of the sample.
6. Press the  key to save the temperature value.
Alternatively, press the  key to quit and retain the current setting.

9. Good Laboratory Practices (GLP)



The **WP-90** keeps a record of the date and time of the last Specific Ion, pH and Temperature calibrations as part of GLP guidelines.

9.1 To recall GLP information on the display

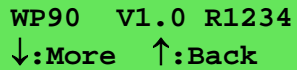
1. Switch the meter on.
2. Select the GLP menu. ( → **F4:Setup** → **F3:GLP**)
3. Select **F1:Recall**.
4. The instrument model, firmware version number, and instrument serial number are displayed, along with a prompt describing how to scroll through the GLP information.



```
WP90 V1.0 R1234
↓:More ↑:Back
```

5. Press the  key to sequentially scroll through the GLP information for all parameters. Press the  key to scroll back to previous data. The sequence of information displayed is shown over the page. Press  to abort at any time.

GLP Display sequence...

WP90 V1.0 R1234
↓:More ↑:Back



Ion Offs 10.0mv
@ 31/12/98 11:00



Ion Slope 99.0%
@ 31/2/98 11:10



pH Asy 0.10pH
@ 31/12/98 11:20



pH Slope 99.0%
@ 31/12/98 11:30



Temp Offset 1.0^oc
@ 31/12/97 11:40



Exit

9.2 Failed Calibration

If calibration has failed, the GLP function will reset the date and time to zero. The **WP-90** still shows the results of the last successful calibration. These calibration values are still used if further measurements are taken without re-calibrating. For example...

```
Ion Offs   10.0mv
@ 00/00/00 00:00
```

```
Ion Slope  99.0%
@ 31/2/98 11:10
```

```
pH Asy    0.10pH
@ 31/12/98 11:20
```

```
pH Slope  99.0%
@ 31/12/98 11:30
```

```
Temp Offset 1.0°C
@ 31/12/97 11:40
```

9.3 Printing GLP Information to the RS232 Port

The GLP information stored in the instrument's memory can be sent to a printer or PC via the RS232 port.

Switch the meter on.

Ensure that the **WP-90** RS232 cable is connected to the instrument and to the printer or PC.

Select the GLP menu. ( → **F4:Setup** → **F3:GLP**)

Select **F3:Print**.

The GLP information is sent to the RS232 port in formatted ASCII text.

For example...

```
WP90  V1.0 R1234 @ 31/12/98 12:00
Ion      Offset=    10.0mV @ 31/12/98 11:00
Ion      Slope=     99.0% @ 31/12/98 11:10
pH       Asy=       0.10pH @ 31/12/98 11:20
pH       Slope=     99.0% @ 31/12/98 11:30
Temperature Offset=  1.0oC @ 31/12/98 11:40
ENDS
```

9.4 Instrument Serial Number

In case the barcode serial number that is fitted to the rear of the **WP-90** is removed or becomes illegible, it is also available on the **WP-90** display.

- The serial number is displayed at turn-on...

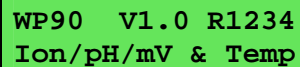

WP90 V1.0 R1234
Ion/pH/mV & Temp

where **R1234** is the serial number.

- The serial number is displayed when recalling the GLP information (section 9.1).
- The serial number is included on the printout of GLP information (section 9.3).

9.5 Additional GLP Features

Another GLP requirement is to record the date and time of every reading. The **WP-90** does this for you when readings are recorded either with the Notepad function (section 10.1) or the Automatic Logging function (section 11).

10. Notepad Function

10.1 Recording Readings into the Notepad

To record readings into the Notepad memory:

1. Press **F1** in normal display mode. The display should now look like this...

```
100.0ppM  25.0°C
F1:  1  12:00:00
```

2. Press **F1**, to record the current Specific Ion/pH/mV, Temperature, Date and Time into the notepad, and labelled as reading number 1.
3. Repeat steps 1 & 2 as often as required. The maximum number of readings that can be stored in the Notepad is 2400.

10.2 Recalling Records from the Notepad

To recall records from the Notepad onto the **WP-90** display...

1. Select the Notepad menu (**Menu** → **F2:Notepad**)
2. Select **F1:Recall** from the menu.
3. Record number 1 is now displayed. For example...

```
100.0ppM  25.0°C
#  1  F2:Clk
```

4. Press **F2** to alternate between the data and the date and time for this record. For example...

```
100.0ppM  25.0°C
#  1  F2:Clk
```

← **F2** →

```
31/12 12:00:00
#  1  F2:Dat
```

5. Press **▲** to move forward through the records.
 Press **▼** to move backward through the records.
 Press and hold the **▲** or **▼** keys to roll rapidly through the readings.

10.3 Erasing Records from the Notepad

To erase all records from the Notepad...

1. Select the Notepad menu ( → **F2:Notepad**)
2. Select **F2:Erase** from the menu.
3. The **WP-90** now asks if you are sure that you wish to erase all records.

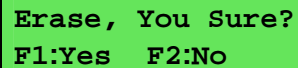

Erase, You Sure?
F1:Yes F2:No

4. Press **F1** to erase all records from the Notepad.
Press **F2** to quit without erasing the records from the Notepad.

10.4 Printing Records from the Notepad to the RS232 Port

1. Connect one end of the RS232 cable to the **Charger/RS232** socket of the **WP-90**. The charger, optional solar panel, or optional car battery lead can be connected into the spare socket on the cable for long term use, if required.
2. Connect the other end of the RS232 cable to an RS232 Printer, or to COM1 or COM2 of a PC.
3. Ensure that the baud rate for the printer or PC and the **WP-90** are the same.

If necessary, alter the baud rate of the **WP-90** (see section 12.1).

The **WP-90** uses XON/XOFF protocol. Ensure that the printer is set accordingly.

4. Select the Notepad menu ( → **F2:Notepad**).
5. Select **F3:Print** from the menu.
Printing starts as soon as **F3** is pressed. The display shows the word "**Printing**" until printing is completed.

11. Automatic Datalogging





The **WP-90** can automatically log readings. First the logging period must be programmed, then automatic logging can be started and stopped as required.

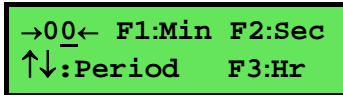

1. Select the Notepad menu ( → **F2:Notepad**).
2. Select **F4:Prog.** from the menu.

The display should now look like this...



```
→00← F1:Min F2:Sec
↑↓:Period F3:Hr
```

3. Use the  and  keys to set the period at which the **WP-90** will automatically log records.
4. When the logging period has been correctly set, select whether this period is in minutes, seconds or hours.
Press  to save the period as minutes.
Press  to save the period as seconds.
Press  to save the period as hours.

For example, if the period is set to **05**, followed by  , then the **WP-90** will automatically log a record every 5 seconds.
5. The **WP-90** will ask if the records are to be logged into the Notepad, or sent directly to the RS232 port.
Press  to log records into the Notepad (maximum of 2400 readings).
Press  to send records directly to the RS232 port.
6. The automatic logging function is now programmed, and can be started and stopped as required.

7. To start automatic logging, press **F3** in normal display mode.

If the **WP-90** is logging into the Notepad, the display will look like this...

```
100.0ppM    25.0°C  
Log#  1 12:00:00
```

The log number will increment and the **WP-90** will beep each time a reading is recorded.

If the **WP-90** is sending records directly to the RS232 port, the display will look like this...

```
100.0ppM    25.0°C  
Sending 12:00:00
```

The **WP-90** will beep each time a record is sent to the RS232 port.

8. Press **F3** to stop automatic logging.

Notes:

1. The clock must be set before the **WP-90** will allow automatic logging to start. The message "**Clock Not Set**" is displayed if the clock is not set.
2. The Battery Saver function (section 13) is disabled while the meter is in Automatic Datalogging mode, to stop the meter switching off while logging data. Even when the memory is full and the meter stops logging, the Battery Saver function is still disabled. This allows the data to be downloaded and the memory to be reset remotely.

12. RS232 Port



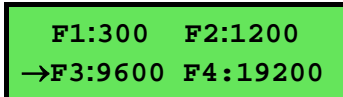

12.1 Setting the Baud Rate

1. Select the RS232 Set-up menu ( → **F4:Setup** → **F4:Baud**)
2. The available baud rates are listed on the display...



```
F1:300  F2:1200
→F3:9600 F4:19200
```

The arrow shows the current selection.

3. Press  to select 300 baud
Press  to select 1200 baud
Press  to select 9600 baud
Press  to select 19200 baud.
Press  to quit and retain the current setting.

12.2 Sending Readings to the RS232 Port

Press  to instantly send readings to the RS232 port whenever the **WP-90** is in normal display mode. This function is disabled if the automatic logging period is set to greater than zero (see section 11).

Records can be sent directly to the RS232 port rather than stored in memory during automatic datalogging. See section 11 for details.

12.3 RS232 Configuration

The **WP-90** RS232 configuration is 8 bits, No Parity, 1 Stop Bit, XON/XOFF Protocol.

12.4 Communication and Statistical Software

Communication between the **WP-90** and a PC can be handled with any RS232 communication software. The diskette supplied by TPS contains a BASIC program for this purpose. A Windows[®] version is also optionally available.

Once the data is saved to disk, the next problem is how to use it. The data is formatted columns that can be imported by programs such as Microsoft[®] Excel[®] and Lotus 123[®].

Information on how to use the software is provided in the README files on the diskette.

12.5 Commands

The following commands can be sent from a PC to the **WP-90**. Note that <cr> denotes carriage return and <lf> denotes a line feed.

Action	Command	Notes
Request current data	?D<cr>	Returns the current Specific Ion/pH/mV, Temperature, date and time from the WP-90 . The log number returned is set to zero.
Request logged data	?R<cr>	Returns all logged records from the WP-90 memory. The data ends with the message ENDS<cr>
Erase logged data	?E<cr>	Erases all logged records from the WP-90 memory. Returns the message ERASED<cr> to confirm that the records have been erased.
Request status information	?S<cr>	Returns the model name, firmware version number, instrument serial number and number of logged readings in memory, eg: WP90••V1.0•R1234•9999<cr> , where • are spaces. Note that the number of logged readings is right-justified.
Request GLP information	?G<cr>	Returns all calibration GLP information, plus the instrument model and current date (see section 12.6 for data format and handshaking).

12.6 Data Format

Data is returned to the RS232 port by the **WP-90** in the following format...

LLLL♦DDDDDDDDUUU♦TTTTTTTTuuu♦dd/mm/yy♦hh:mm:ss

where...

LLLL	is the Log Number. Maximum 4 characters, right justified. The WP-90 sends a Zero for instant readings (section 12.2)
♦	is one space.
DDDDDDDD	is Specific Ion, pH, mV or Relative mV data, maximum 8 characters, right justified.
UUU	is the unit description. Either “ppM”, “ppK”, “pH♦”, “mV♦”, “mVR”. “♦♦♦” is sent for Exponential readout of Specific Ions.
♦	is one space. (♦ are spaces.)
TTTTTTTT	is the Temperature Data, maximum 8 characters, right justified.
uuu	is the Temperature unit description. Either “oC♦” for real temperature data (where ♦ is 1 space), or “oCm” for manual temperature compensation data.
♦	is one space.
dd/mm/yy	is the date, month and year data.
♦	is one space.
hh:mm:ss	is the hours, minutes and seconds data.

When data is requested by a PC with the ?D or ?R commands (section 12.5), it is terminated with a carriage return.

When data is sent by the **WP-90** using the Print function (section 10.4) or the Instant Send function (section 12.2), the data ends with a carriage return and a line feed.

12.7 GLP Data Format

GLP information is returned as 7 lines terminated by a carriage return. When using the "?G" command (section 12.5), the computer must respond with a character after receiving each line.

For example...

```
WP90 V1.0 R1234 @ 31/12/98 12:00
Ion      Offset=    10.0mV @ 31/12/98 11:00
Ion      Slope=     99.0% @ 31/12/98 11:10
pH       Asy=       0.10pH @ 31/12/98 11:20
pH       Slope=     99.0% @ 31/12/98 11:30
Temperature Offset=  1.0oC @ 31/12/98 11:40
ENDS
```

13. Battery Saver Function

The **WP-90** is equipped with a battery saver function. If no button has been pressed for five minutes, the unit beeps and flashes the display for 20 seconds, and then shuts off. This function can be switched off for continuous use.

To enable or disable the battery saver function...

1. Switch the meter on.
2. Select Battery Saver Set-up ( → **F4:Setup** → **F1:Batt**)

The battery saver menu is now displayed...



The arrow indicates the current selection.

The bar graph and percentage indicate the approximate level of charge in the battery.

3. Press **F1** to disable the battery saver function for continuous use.
Press **F2** to enable the battery saver function. The meter will switch itself off if no key has been pressed for five minutes.
Press  to quit the battery saver menu and retain the current setting.

Notes:

1. For troubleshooting purposes, the battery volts can also be displayed in the battery saver menu. Press **F3** to display battery volts.
2. The Battery Saver function is disabled while the meter is in Automatic Datalogging mode (section 11), to stop the meter switching off while logging data. Even when the memory is full and the meter stops logging, the Battery Saver function is still disabled. This allows the data to be downloaded and the memory reset remotely.

14. Recharging the Battery

The  symbol flashes when the battery drops below 5.60 volts. The battery should be recharged at this point. If the battery is not recharged, the **WP-90** will switch itself off when the battery drops below 5.00 volts.

To recharge the battery...

1. Plug the battery charger, solar panel, or car cigarette lighter adaptor into the **Charger/RS232** socket. **DO NOT** plug into the **Temperature** socket, as this will damage the **WP-90**.
2. Charge for approximately 8 hours for full capacity. The **WP-90** has special circuitry to prevent overcharging, so the charger can be used continuously.
3. To ensure optimum battery life and capacity, the **WP-90** should only be charged once the  symbol starts to flash.

15. Clock Function







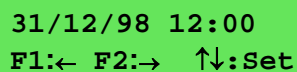









15.1 Setting the Clock

1. Select the Clock Set-up menu ( → **F4:Setup** → **F2:Clock**).

The display now shows the current date and time. The cursor starts at the day.





```
31/12/98 12:00
F1:← F2:→ ↑↓:Set
```

2. Press the  and  keys until the day is correct.
3. Press  to move to the month. Press the  and  keys until the month is correct.
4. Press  to move to the year. Press the  and  keys until the year is correct.
5. Press  to move to the hour. Press the  and  keys until the hour is correct.
6. Press  to move the cursor to the minutes. Press the  and  keys until the minutes are correct.
7. Check that the date and time are correct.
If any changes are needed, press the  key to move left to the desired position.
8. Press  when the cursor is in the “minutes” position to save the settings.
Press  to quit without resetting the clock.

Note

The **WP-90** does not test for a valid day of the month when setting the clock (eg: attempting to enter 31/02/96 is not corrected).

15.2 Displaying or Hiding the Clock

Date and time are normally displayed along with the Specific Ion/pH/mV and Temperature readings. Press  in normal display mode to alternatively display or hide the clock. When Relative mV is selected, the  key alternatively displays the clock or absolute mV.

16. Selecting Buffers for Auto Buffer Recognition

The **WP-90** is factory set to automatically recognise pH4.00, pH6.88 and pH9.23 buffers. However, some users may prefer to use pH7.00 instead of pH6.88 and pH10.00 instead of pH9.23. The following procedure describes how to set which of these buffers are automatically recognised at calibration.

1. Switch the meter **OFF**.
2. Press and HOLD the F1 key while switching the meter back on.

The buffer selection menu is now displayed.

```
Select →F1:6.88pH
Buffer F2:7.00pH
```

The arrow indicates the current selection.

3. Press F1 to select pH6.88 as the primary buffer.
Press F2 to select pH7.00 as the primary buffer.
Press Menu to quit buffer selection and retain the current setting.
4. The display will now show the currently selected high pH buffer.

```
Select →F1:9.23pH
Buffer F2:10.0pH
```

The arrow indicates the current selection.

5. Press F1 to select pH9.23 as the high pH buffer.
Press F2 to select pH10.00 as the high pH buffer (the display shows 10.0 for the latter, but this buffer is stored as pH10.00).
6. Press Menu to quit buffer selection and retain the current setting.
7. The setting is kept in memory when the meter is switched off, even if the battery is removed. The buffers are re-set to pH6.88 and pH9.23 during initialisation.

Note:

pH6.88 buffer is a DIN 19266 and NBS Primary-standard pH solution. Its use is highly recommended for the most accurate possible results. If pH7.00 buffer is used, ensure that it is manufactured to 0.01pH accuracy. pH7.00 buffer has a buffer capacity less than half that of pH6.88 buffer and is therefore much less stable.

17. Initialising the WP-90

If the calibration settings of the **WP-90** exceed the allowable limits, the unit may need to be initialised to factory default values.

To initialise the **WP-90**...

8. Switch the **WP-90 OFF**.
9. Press and HOLD the  key while switching the **WP-90** back on.

The following messages should be displayed...

```
Initialized
MUST ReCalibrate
```

then:

```
WP90s V1.0 R1234
Ion/pH/mV & Temp
```

(The “s” after **WP-90** is shown when the RS232 serial port option is fitted)

10. The meter then displays Specific Ion and Temperature. Note that the decimal points have been replaced with a *, to indicate that the unit requires re-calibration.

Note:

When the **WP-90** is initialised, the primary pH buffer is re-set to pH6.88 and the high pH buffer is re-set to pH9.23. See section 16 if you wish to use pH7.00 and/or pH10.00 buffers.

18. Instrument firmware version number.

If you need to phone or fax TPS for any further technical assistance, the version number of your **WP-90** firmware may be of benefit to us. The version number is displayed by the **WP-90** at turn-on. In the example below, the firmware version number is **V1.0**.

```
WP90s V1.0 R1234
Ion/pH/mV & Temp
```

19. Troubleshooting

19.1 General Errors

Error Message	Possible Causes	Remedy
Factory Cal. Failed	The EEPROM chip which contains the factory calibration information has failed.	The unit must be returned to TPS for service.
Memory Failed Calibration Lost then: Initialised MUST ReCalibrate	User calibration settings have been lost or corrupted.	Re-calibrate the instrument... <ul style="list-style-type: none"> • 2-point calibration for Specific Ion (section 4.1). • 2-point calibration for pH (section 5.1). • 1-point calibration for temperature (section 8.1).
Flashing  symbol.	Battery is below 5.60 volts.	Recharge the battery. Note that the unit will switch itself off when the battery falls below 5.00 volts.
Meter displays the word OFF , and switches off.	Battery is below 5.00 volts.	Recharge the battery. If this fails, check the charger. If charger OK, replace the battery.
Meter will not turn on.	<ol style="list-style-type: none"> 1. Battery is exhausted. 2. Faulty Instrument 	Recharge the battery. If this fails, check the charger. If charger OK, replace the battery. Return to factory for repair.
Battery does not charge up when charger is connected.	<ol style="list-style-type: none"> 1. Faulty battery charger or faulty battery. 2. Faulty instrument. 	Connect the charger and switch the power on. Display the battery volts in the battery saver menu (section 13). If the battery volts are increasing then the charger is OK. If the battery volts do not increase, then the charger is faulty. Replace the charger or the battery, as required. Return to factory for repair.

19.2 Specific Ion, pH and mV Troubleshooting

Symptom	Possible Causes	Remedy
Unit fails to calibrate, even with new probe.	Calibration settings outside of allowable limits due to previous failed calibration.	Initialise the unit. See section 17.
1 Point calibration fails (Specific Ion offset causes over-range reading, or pH asymmetry is greater than ± 1.00 pH.)	<ol style="list-style-type: none"> Reference junction blocked. Reference electrolyte contaminated. 	<p>Clean reference junction, as per instructions supplied with the pH or reference sensor.</p> <p>Flush with distilled water and replace electrolyte.</p>
2 Point calibration fails (Specific Ion slope is less than 50% or pH Slope is less than 85%).	<ol style="list-style-type: none"> Incorrect primary Ion Standard or pH Buffer. Ion sensor surface or pH glass bulb not clean. Sensor is aged. Connector is damp. Ion Standard or pH Buffers are inaccurate. 	<p>Ensure that you are using the primary Ion Standard or pH Buffer for which the WP-90 has been set (sections 3 & 16).</p> <p>Clean Ion sensor or pH glass bulb as per instructions supplied with the sensor.</p> <p>Attempt rejuvenation, as per instructions supplied with the sensor. If not successful, replace sensor.</p> <p>Dry in a warm place.</p> <p>Replace standards or buffers.</p>

Continued next page...

Specific Ion, pH and mV Troubleshooting, continued...

Unstable readings.	<ol style="list-style-type: none"> 1. Reference electrolyte chamber needs to be refilled. 2. Reference junction blocked. 3. Ion sensor surface or pH glass bulb not clean. 4. Bubble in tip of Ion sensor or pH glass bulb. 5. Faulty connection to meter. 6. Reference junction not immersed. 7. KCl crystals around reference junction, inside the electrolyte chamber. 	<p>Refill electrolyte. See Ion sensor specifications for correct electrolyte. Use saturated KCl for pH sensor.</p> <p>Clean reference junction, as per instructions supplied with the sensor.</p> <p>Clean Ion sensor or pH glass bulb as per instructions supplied with the sensor.</p> <p>Flick the sensor to remove bubble.</p> <p>Check connectors. Replace if necessary.</p> <p>Ensure that the reference junction is fully immersed.</p> <p>Rinse electrolyte chamber with warm distilled water until dissolved. Replace electrolyte.</p>
Inaccurate readings, even when calibration is successful.	Reference junction blocked.	Clean reference junction, as per instructions supplied with the sensor.
Displays constant Specific Ion readings or pH7.00 for all solutions.	Electrical short in connector.	<ol style="list-style-type: none"> 1. Check connector. Replace if necessary. 2. Replace sensor.
Displays constant Specific Ion readings or pH4 to 6 for all solutions.	Ion sensor surface, pH glass bulb cracked, or internal damage.	Replace sensor.

19.3 Temperature Troubleshooting

Symptom	Possible Causes	Remedy
Displays "OVR°c" when Temperature sensor is plugged in.	<ol style="list-style-type: none"> 1. Faulty temperature sensor. 2. Faulty instrument. 	<p>Return sensor to factory for repair or replacement.</p> <p>Return to factory for repair.</p>
Temperature inaccurate and cannot be calibrated.	<ol style="list-style-type: none"> 1. Faulty connector. 2. Faulty Temperature sensor. 3. Faulty instrument. 	<p>Check the connector and replace if necessary.</p> <p>Return sensor to factory for repair or replacement.</p> <p>Return to factory for repair.</p>

20. pH Sensor Fundamentals

A combination pH Sensor is two sensors in one. The sensing membrane is the round or spear shaped bulb at the tip of the sensor. This produces a voltage that changes with the pH of the Solution. This voltage is measured with respect to the second part of the sensor, the reference section. The reference section makes contact with the sample solution using a salt bridge, which is referred to as the reference junction. A saturated solution of KCl is used to make contact with the sample. It is vital that the KCl solution has an adequate flow rate in order to obtain stable, accurate pH measurements.

20.1 Asymmetry of a pH Sensor

An "ideal" pH sensor produces 0 mV output at 7.00 pH. In practice, pH sensors, generally produce 0 mV output at slightly above or below 7.00 pH. The amount of variance from 7.00 pH is called the asymmetry. Figure 20-1 illustrates how asymmetry is expressed.

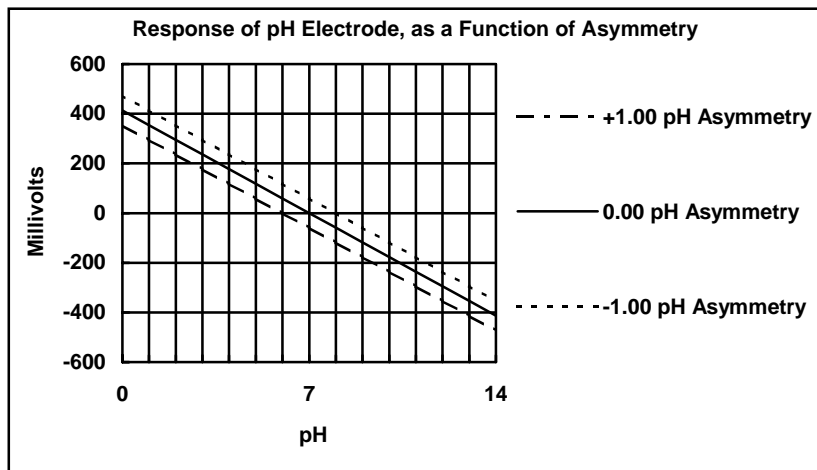

Figure 20-1

20.2 Slope of a pH Sensor

As mentioned above, a pH sensor produces 0 mV output at around 7.00 pH. As the pH goes up, an "ideal" pH sensor produces -59mV/pH unit at 25 °C. As the pH goes down, an ideal pH sensor produces +59mV/pH unit. In practice, pH sensors usually produce slightly less than this. The output of a pH sensor is expressed as a percentage of an ideal sensor. For example, an ideal sensor that produces 59mV/pH unit has "100% Slope". An sensor that produces 50.15mV/pH unit has "85% Slope" (see Figure 20-2).

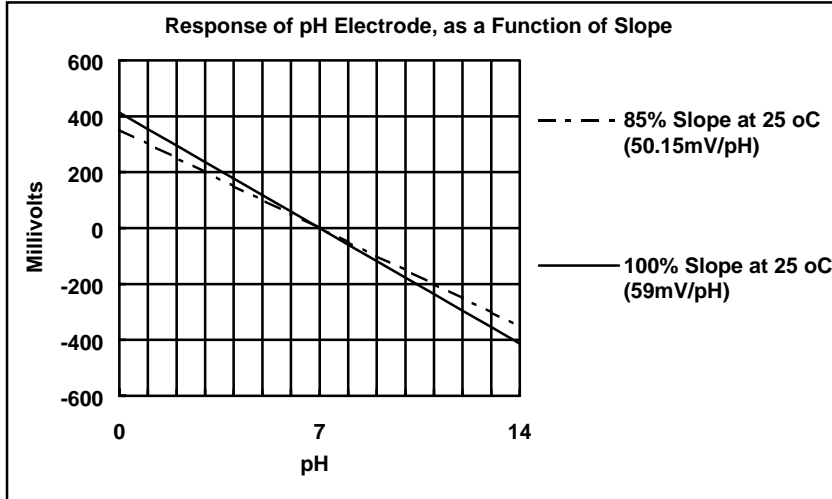

Figure 20-2

20.3 pH Temperature Compensation

The slope of a pH sensor (section 20.2) is affected by temperature. This effect is compensated for either by using an Automatic Temperature Compensation (ATC) probe or by entering the sample temperature manually. Figure 20-3 shows the slope of a pH sensor at various temperatures.

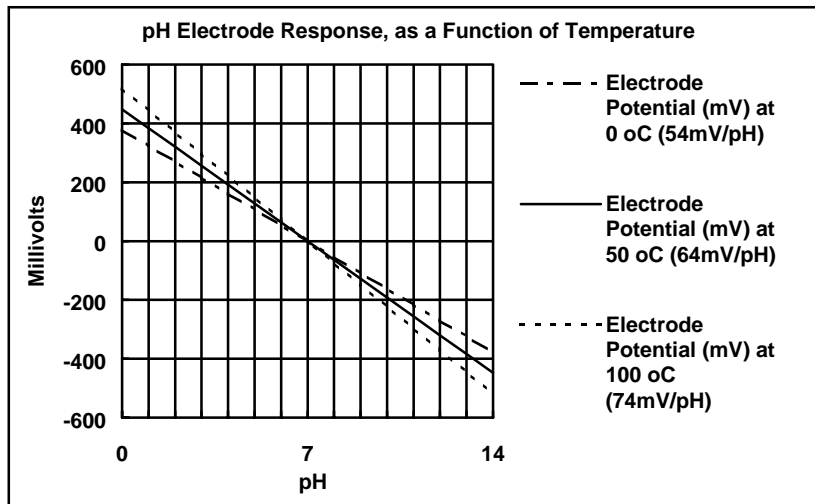

Figure 20-3

20.4 Checking the reference junction of a pH sensor

If pH readings are inaccurate or unstable, the reference junction of the sensor may be blocked. The following test can be performed to determine if the reference junction of a pH sensor is making adequate contact with the sample solution.

1. Calibrate the **WP-90**, as per section 5.1.
2. Dilute 1 part of pH6.88 buffer with 9 parts of distilled water.
3. Measure the pH of the diluted buffer. The result should be 7.06 +/-0.02 pH.
4. If the value obtained is outside of these limits, then clean the reference junction, as per the instructions supplied with the pH sensor.
5. Re-calibrate the **WP-90** and repeat the test.
6. If the value obtained is still outside 7.06 +/-0.02 pH, then the sensor should be replaced.

20.5 Determining if a pH meter or a sensor is faulty

The following test can be performed to help determine if the **WP-90** or the pH sensor is faulty.

1. Initialise the **WP-90** (see section 17).
2. Disconnect the pH sensor.
3. Connect the centre pin of the **SENSOR** connector with the outside frame of the connector, using a short piece of wire or a paper clip etc.
4. The meter should read approximately 7.00. The **WP-90** will now pH calibrate to around 6.88 or 7.00 pH, depending upon the temperature readout and the primary buffer selection (section 16).
5. If the **WP-90** is operating correctly, the reading should be totally stable with the wire firmly in place. If not, the meter requires servicing.
6. Now carefully disconnect the wire from the centre pin only (make sure the other end of the wire remains connected to the outside frame of the connector).
7. The reading should steadily drift away from 6.88 or 7.00 (either up or down) at a rate of approximately 1 pH or less every 3 seconds. If the drift rate is faster than this, then input circuitry of the **WP-90** is faulty and requires servicing.

21. Warranty

TPS Pty. Ltd. guarantees all instruments and sensors to be free from defects in material and workmanship when subjected to normal use and service. This guarantee is expressly limited to the servicing and/or adjustment of an instrument returned to the Factory, or Authorised Service Station, freight prepaid, within twelve (12) months from the date of delivery, and to the repairing, replacing, or adjusting of parts which upon inspection are found to be defective. Warranty period on sensors is three (3) months.

There are no express or implied warranties which extend beyond the face hereof, and TPS Pty. Ltd. is not liable for any incidental or consequential damages arising from the use or misuse of this equipment, or from interpretation of information derived from the equipment.

Shipping damage is not covered by this warranty.

PLEASE NOTE

A guarantee card is packed with the instrument or sensor. This card must be completed at the time of purchase and the registration section returned to TPS Pty. Ltd. within 7 days. No claims will be recognised without the original guarantee card or other proof of purchase. This warranty becomes invalid if modifications or repairs are attempted by unauthorised persons, or the serial number is missing. simultaneously

PROCEDURE FOR SERVICE

If you feel that this equipment is in need of repair, please re-read the manual. Sometimes, instruments are received for "repair" in perfect working order. This can occur where batteries simply require replacement or re-charging, or where the sensor simply requires cleaning or replacement.

TPS Pty. Ltd. has a fine reputation for prompt and efficient service. In just a few days, our factory service engineers and technicians will examine and repair your equipment to your full satisfaction.

To obtain this service, please follow this procedure:

Return the instrument AND ALL SENSORS to TPS freight pre-paid and insured in its original packing or suitable equivalent. INSIST on a proof of delivery receipt from the carrier for your protection in the case of shipping claims for transit loss or damage. It is your responsibility as the sender to ensure that TPS receives the unit.

Please check that the following is enclosed with your equipment:

- **Your Name and daytime phone number.**
- **Your company name, ORDER number, and return street address.**
- **A description of the fault. (Please be SPECIFIC.)**
(Note: "Please Repair" does NOT describe a fault.)

Your equipment will be repaired and returned to you by air express where possible.

For out-of-warranty units, a repair cost will be calculated from parts and labour costs. If payment is not received for the additional charges within 30 days, or if you decline to have the equipment repaired, the complete unit will be returned to you freight paid, not repaired. For full-account customers, the repair charges will be debited to your account.

- **Always describe the fault in writing.**
- **Always return the sensors with the meter.**