

## **Congratulations !**

You have purchased the latest in Handheld Turbidity instrumentation. We trust that your new **WP-88** will give you many years of reliable service.

The **WP-88** is a breeze to operate. This manual has been designed to help you get started, and also contains some handy application tips. If at any stage you require assistance, please contact either your local TPS representative or the TPS factory in Brisbane, Australia.

---

The manual is divided into the following sections:

### **1. Table of Contents**

Each major section of the handbook is clearly listed. Sub-sections have also been included to enable you to find the information you need at a glance.

### **2. Introduction**

The introduction has a diagram and explanation of the display and controls of the **WP-88**. It also contains a full listing of all of the items that you should have received with your **WP-88**. Please take the time to read this section, as it explains some of items that are mentioned in subsequent sections.

### **3. Main Section**

The main section of the handbook provides complete details of the **WP-88**, including operating modes, calibration, troubleshooting, specifications, and warranty terms.

### **4. Appendices**

Appendices containing background information and application notes are provided at the back of this manual.

**Model WP-88**  
**Turbidity-Temp. Meter**  
Version : 1.2  
Date : 30-Aug-2005  
Author : AB

This page has been intentionally left blank.



**TPS Pty Ltd**

ABN 30 009 773 371

4 Jamberoo Street  
Springwood, Brisbane,  
Australia, 4127

Phone : (07) 32 900 400  
International : 61 7 32 900 400

Fax : (07) 3808 4871  
International : 61 7 3808 4871

Email : [tps@tps.com.au](mailto:tps@tps.com.au)

Web : [www.tps.com.au](http://www.tps.com.au)

## Contents









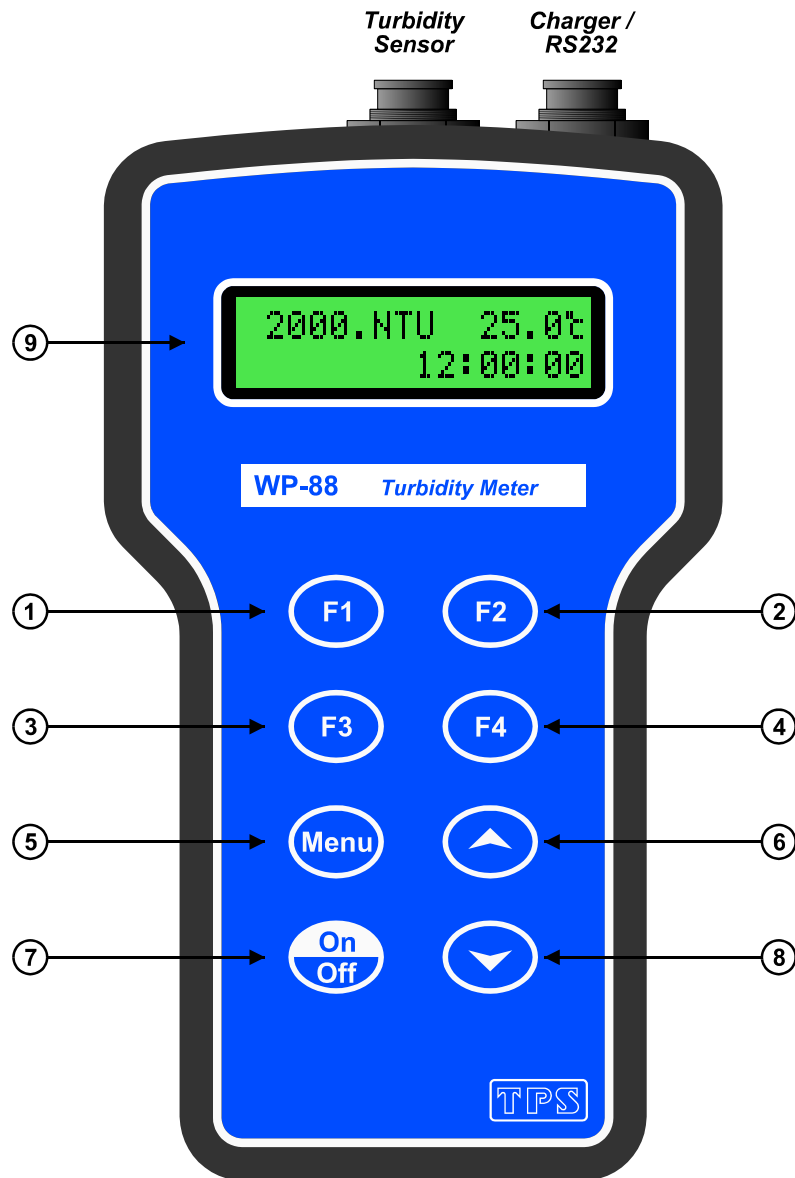

<b>1. Introduction .....</b>	<b>6</b>
1.1 WP-88 Display and Controls .....	6
1.2 Unpacking Information .....	8
1.3 Specifications .....	9
<b>2. Fitting the Cable to the Sensor .....</b>	<b>11</b>
<b>3. Fitting the Protector to the Sensor.....</b>	<b>12</b>
<b>4. WP-88 Menu Structure.....</b>	<b>13</b>
<b>5. Turbidity Calibration.....</b>	<b>14</b>
5.1 Entering the Turbidity Standard Value .....	14
5.2 Calibration Procedure .....	15
5.3 Turbidity Calibration Notes.....	17
5.4 Calibration Messages.....	17
<b>6. Temperature Calibration .....</b>	<b>18</b>
<b>7. Operation of the WP-88 .....</b>	<b>19</b>
<b>8. Good Laboratory Practices (GLP) .....</b>	<b>20</b>
8.1 To recall GLP information on the display .....	20
8.2 Failed Calibration .....	21
8.3 Printing GLP Information to the RS232 Port.....	21
8.4 Instrument Serial Number .....	22
8.5 Additional GLP Features.....	22
<b>9. Notepad Function .....</b>	<b>23</b>
9.1 Recording Readings into the Notepad .....	23
9.2 Recalling Records from the Notepad .....	23
9.3 Erasing Records from the Notepad.....	24
9.4 Printing Records from the Notepad to the RS232 Port.....	24
<b>10. Automatic Datalogging .....</b>	<b>25</b>
<b>11. RS232 Port .....</b>	<b>27</b>
11.1 Setting the Baud Rate .....	27
11.2 Sending Readings to the RS232 Port.....	27
11.3 RS232 Configuration.....	27
11.4 Communication and Statistical Software .....	27
11.5 Commands.....	28
11.6 Data Format .....	29
11.7 GLP Data Format .....	30
11.8 Importing Data into Microsoft Excel .....	31

<b>12.</b>	<b>Battery Saver Function .....</b>	<b>33</b>
<b>13.</b>	<b>Recharging the Battery .....</b>	<b>34</b>
<b>14.</b>	<b>Clock Function.....</b>	<b>35</b>
14.1	Setting the Clock.....	35
14.2	Displaying or Hiding the Clock.....	35
<b>15.</b>	<b>Initialising the WP-88.....</b>	<b>36</b>
<b>16.</b>	<b>Troubleshooting .....</b>	<b>37</b>
16.1	General Errors .....	37
16.2	Turbidity Troubleshooting .....	38
<b>17.</b>	<b>Warranty .....</b>	<b>39</b>

## 1. Introduction

### 1.1 WP-88 Display and Controls



- ①  Press to record readings into memory. See section 9.1.
- ②  Press to show or hide the date and time. See section 14.2.
- ③  Press to start or stop automatic logging. See section 10.  
Alternatively, press to transmit current reading plus date and time to the RS232 port. See section 11.2.
- ④  Used within the menu system only.
- ⑤  Press to access the user-friendly menu system which makes the **WP-88** a breeze to operate.
- ⑥  and ⑧  The  and  keys are used when setting the clock (section 14.1), setting the automatic logging period (section 10), and displaying GLP information (section 8.1).  
The  key is also used to initialise the **WP-88** at turn-on. See section 15.
- ⑦  Switches the **WP-88** on and off.
- ⑨ **Display**  
32 character alpha-numeric display with user-friendly menu and prompting system. Shows Turbidity and temperature simultaneously. Date and time can also be displayed.

**1.2 Unpacking Information**

Before using your new **WP-88**, please check that the following accessories have been included:

	Part No
1. <b>WP-88</b> Turbidity Meter.....	125188
2. Turbidity / Temperature Sensor.....	125186
3. Detachable cable for Turbidity Sensor, 5m .....	125187
4. 900 NTU Secondary Standard, 200mL .....	125220
5. 90 NTU Secondary Standard, 200mL .....	125216
6. Amber Calibration Bottles, 250mL (2 supplied) .....	125300
7. Battery charger .....	130037
8. <b>WP-88</b> Handbook .....	130050

Options that may have been ordered with your **WP-88**:

1. Protector cover for field use .....	125189
2. RS232 Serial Interface Cable.....	130041
3. Communication software for Microsoft Windows 95 .....	130086
and all later versions	
4. USB to Serial Adaptor (required 130041 also).....	130087
5. Hard Carry Case .....	130059
6. 90 NTU Secondary Standard, 1 Litre .....	125214
7. 360 NTU Secondary Standard, 1 Litre .....	125204
8. 360 NTU Secondary Standard, 200 mL .....	125206
9. 900 NTU Secondary Standard, 1 Litre .....	125218
10. 180 NTU Primary Standard, 1 Litre.....	125200
11. 180 NTU Primary Standard, 200mL.....	125202
12. 1800 NTU Primary Standard, 1 Litre .....	125222
13. 1800 NTU Primary Standard, 200 mL.....	125224
14. Battery charger lead for 12V cigarette lighter socket .....	130046
15. Battery charger lead for 12V DC, with battery clips.....	130052
16. Solar Panel.....	130012

Other spares:

1. 6V NiMH Battery.....	130038
-------------------------	--------



### 1.3 Specifications

#### Turbidity

<b>Ranges</b> .....	0 to 200.0 NTU 200 to 2000 NTU (Automatic range selection)
<b>Resolution</b> .....	0.1 NTU 1 NTU
<b>Accuracy</b> .....	±1 NTU

#### Temperature

<b>Range</b> .....	-10.0 to 120.0 °C (sensor limit 0 to 60 oC)
<b>Resolution</b> .....	0.1 °C
<b>Accuracy</b> .....	±0.2 °C

#### General Specifications

Temperature Compensation.....	Automatic, 0 to 60.0 °C
Turbidity Zero Cal Range .....	0 to 15.0 NTU
Turbidity Span Cal Range .....	90 to 110 %
Turbidity Standards .....	Low Range : 30.0 to 180.0 NTU High Range : 200 to 2000 NTU
Memory .....	2400 readings including date and time
Automatic Logging.....	User-set for one reading every 1 to 90 seconds, minutes or hours.
RS232 Output.....	300, 1200, 9600 & 19200 baud. 8 bits, no parity, 1 stop bit, XON/XOFF Protocol.
Clock .....	Calendar clock displays date, month, hours, minutes & seconds. Year is recorded in memory and transmitted to the RS232 port, but is not displayed.

Battery Saver .....	On : Auto switch-off after 5 minutes Off : Continuous use Bar Graph display of battery charge level. Readout of battery voltage available for troubleshooting.
Good Laboratory Practices .....	Date, Time and Value of last Zero and last Span calibrations are stored, and can be recalled or sent to the RS232 port at any time.
Power .....	6V NiMH Rechargeable Battery for approx 50 hours operation.
Dimensions .....	187 x 110 x 51 mm
Mass.....	Instrument only.....: Approx 440g Full Kit .....,.....: Approx 2.0kg
Environment .....	<b>Instrument</b> Temperature.....: 0 to 45 °C Humidity .....,.....: 0 to 90 % R.H. <b>Sensor</b> Temperature Limits ...: 0 to 60 °C

## 2. Fitting the Cable to the Sensor



1. Push the cable plug into the socket in the rear of the Turbidity Sensor. Be sure to align the pins of the plug and socket before inserting.
2. Screw on the retaining nut. Finger tighten only, as over tightening may cause damage to the sensor body.

***DO NOT USE A SPANNER.***

### 3. Fitting the Protector to the Sensor

The extra slide-on plastic protector (part no 125189) is an optional extra.

To fit the protector...



1. Slide the protector onto the Turbidity Sensor until the countersunk holes line up with the tapped holes in the sensor's four feet.
2. Screw in the 4 supplied countersunk 1/8 BSW x 1/4" stainless steel screws. Do not over tighten, as the sensor feet may be damaged.

***DO NOT USE AN ELECTRIC SCREWDRIVER.***

### 4. WP-88 Menu Structure

A detailed breakdown of the menu system of the **WP-88** is shown below. This diagram provides a quick reference for the menu functions available for the **WP-88**.

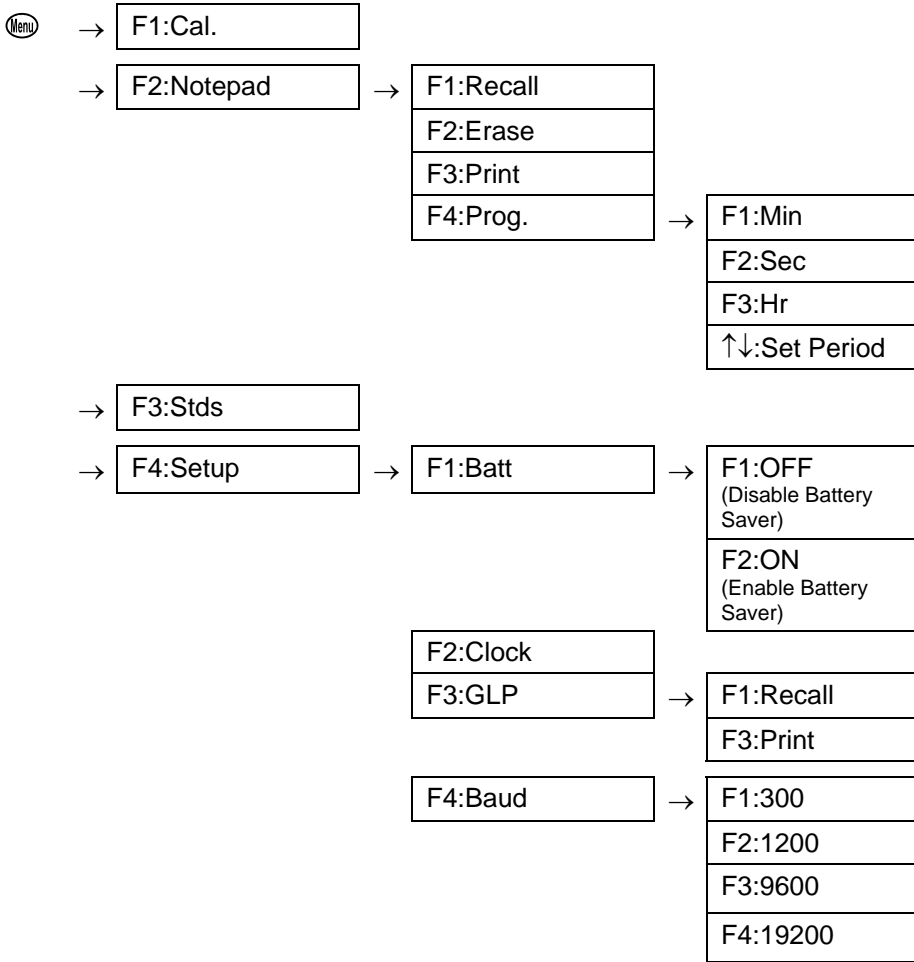

## 5. Turbidity Calibration

A “ \* ” in place of the decimal point indicates that the Turbidity readout of the currently selected mode is not calibrated, or a past calibration has failed. The “ \* ” will be removed once a full two-point Turbidity calibration has been successfully performed.

### 5.1 Entering the Turbidity Standard Value

In order to calibrate the **WP-88** it is first necessary to enter the value of the Turbidity standard which is to be used for calibration. To enter the Turbidity standard value...

1. Plug the Turbidity sensor into the **Turbidity** socket.
2. Switch the meter on.
3. Select the Set Standards menu (Menu → **F3:Stds**).
4. The Turbidity standard for the Low Turbidity mode can entered, for example...

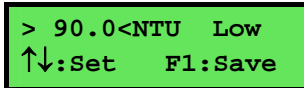

> 90.0<NTU Low  
↑↓:Set F1:Save

Press the ▲ and ▼ keys until the display shows the value of the Turbidity standard. The allowable range is 30.0 to 180.0 NTU.

Press (F1) to save the Turbidity standard value.

Press (Menu) to retain the current setting and move to the high range Turbidity standard.

5. The Turbidity standard for the High Turbidity mode can now be entered, for example...

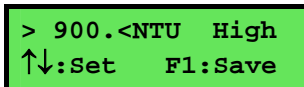

> 900.<NTU High  
↑↓:Set F1:Save

Press the ▲ and ▼ keys until the display shows the value of the Turbidity standard. The allowable range is 300 to 2000 NTU.

6. Press (F1) to save the Turbidity standard value.

Alternatively, press (Menu) to quit and retain the current setting.

## 5.2 Calibration Procedure

1. Plug the Turbidity sensor into the **Turbidity** socket.
2. Switch the meter on.
3. Rinse the Turbidity sensor in distilled water and blot dry.

### Zero Calibration

4. Place the Turbidity sensor into a sample of fresh Distilled water (NOT the rinse water used in step 3). If possible, the vessel should have black or dark floor and walls to avoid reflection affecting the reading. Ensure that there is a minimum of 30mm clearance to the floor and walls of the vessel, as per the following diagram...

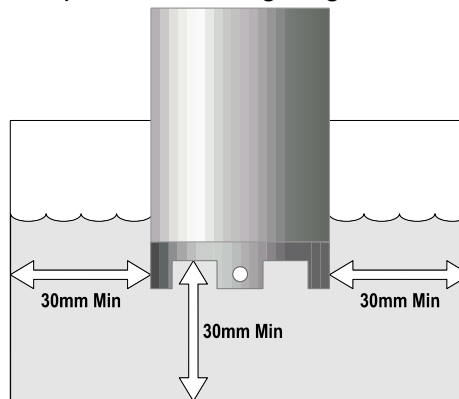

Take care to ensure that there are no bubbles trapped on the underside of the sensor. Bubbles can interfere with Turbidity measurements. Gently stir the sample or the sensor to dislodge any bubbles.

5. Select Calibration (Menu) → **F1:Cal.**). The following screen will be displayed...

```
0*1NTU 25.0°C
F1:Cal at Zero
```

6. When the reading has stabilised at or near zero, press (F1) to calibrate. Note that a “ \* “ will not be removed until a full two point calibration has been performed.

**Continued over the page...**

### **Span Calibration**

7. Place the Turbidity sensor into a sample of Turbidity standard. If possible, the vessel should have black or dark floor and walls to avoid reflection affecting the reading. Ensure that it is immersed correctly, as per the diagram in step 4, above.
8. Select Calibration (Menu → **F1:Cal.**). The following screen will be displayed...

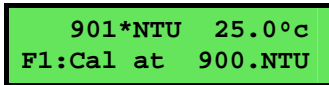

901\*NTU 25.0°C  
F1:Cal at 900.NTU

9. When the reading has stabilised, press (F1) to calibrate. The “\* ” will now be replaced by a decimal point if calibration was successful.
10. The **WP-88** is now calibrated for Turbidity and is ready for use in this mode. Ensure that the **WP-88** is calibrated on the range in which it will be used.

Discard the used samples of distilled water and standard.

Ensure that the sensor is immersed with at least the same clearance as per the diagram in step 5 for all sample measurements.



### 5.3 Turbidity Calibration Notes

1. Calibration information for the Low and High Turbidity modes is stored separately. Ensure that the sensor has been calibrated in the required mode.
2. Calibration information is stored in the Turbidity sensor. It is therefore possible to change sensors without recalibrating, providing the new sensor has been calibrated in the required mode.
3. Frequency of calibration depends on the significance of the results. The Turbidity sensor uses precision optics and electronics, minimising the need to recalibrate frequently.
4. All calibration information can be recalled or printed using the GLP function (see section 7).
5. Always ensure that the value of the Turbidity standard displayed during calibration corresponds to the standard that is actually being used.

### 5.4 Calibration Messages

1. If a Zero calibration has been successfully performed, the **WP-88** will display the following message, and the Low and High range Zero values of the sensor. For example...

```
Calibrate OK
Lo Zero= 0.1NTU
```

then :

```
Calibrate OK
Hi Zero= 1.NTU
```

2. If a Zero calibration has failed, the **WP-88** will display the following message, and the failed Zero value of the sensor. For example:

```
Calibrate Fail
Lo Zero= 110.NTU
```

3. If a Span calibration has been successfully performed, the **WP-88** will display the following message, and the Span value of the sensor. For example...

```
Calibrate OK
Span= 100.2%
```

4. If a Span calibration has failed, the **WP-88** will display the following message, and the failed span value of the sensor. For example...

```
Calibrate Fail
Span= 150.0%
```

## **6. Temperature Calibration**

The Temperature reading from the Turbidity sensor is calibrated in the factory. No user calibration is therefore required.

## 7. Operation of the WP-88

1. Plug the Turbidity sensor into the **Turbidity** socket.
2. Switch the meter on.
3. Rinse the Turbidity sensor in distilled water and blot dry.
4. Place the Turbidity sensor into the unknown sample to be measured. The TPS Turbidity sensor is designed for in situ measurements, so the sensor can simply be immersed into the body of water to be measured.

When taking measurements in a sample vessel, the vessel should have a black or dark floor and walls to avoid reflection affecting the reading. Ensure that there is a minimum of 30mm clearance to the floor and walls of the vessel, as per the following diagram...

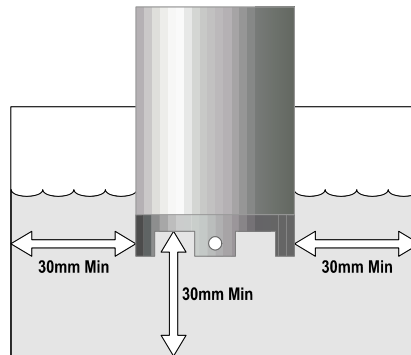

Take care to ensure that there are no bubbles trapped on the underside of the sensor. Bubbles can interfere with Turbidity measurements. Gently stir the sample or the sensor to dislodge any bubbles.

5. The measurement may be recorded when reading has stabilised. The Notepad function is ideal for this purpose (see section 9).
6. Clean and rinse the sensor (especially the glass lenses), with distilled water after use. This is particularly important after use in high Turbidity standards or sample solutions.



## 8. Good Laboratory Practices (GLP)

The **WP-88** keeps a record of the date and time of the last Zero and Span calibrations independently for Low and High Turbidity modes as part of GLP guidelines.

### 8.1 To recall GLP information on the display

1. Switch the meter on.
2. Select the GLP menu (  → **F4:Setup** → **F3:GLP**).
3. Select **F1:Recall** from the menu.
4. The instrument model, firmware version number, and instrument serial number are displayed, along with a prompt describing how to scroll through the GLP information. For example...

```
WP88 V1.1 T1234
↓:More ↑:Back
```

5. Press the  key to sequentially scroll through the GLP information for all parameters. Press the  key to scroll back to previous data. The sequence of information displayed is shown below. Press  to abort at any time.

```
WP88 V1.1 T1234
↓:More ↑:Back
↓:↓ ↑:↑
Turbidity Probe
V1.1 T4321
↓:↓ ↑:↑
Lo Zero 1.0NTU
@ 31/12/04 11:00
↓:↓ ↑:↑
Lo Span 100.2%
@ 31/12/04 11:10
↓:↓ ↑:↑
Hi Zero 1.NTU
@ 31/12/04 11:20
↓:↓ ↑:↑
Hi Span 100.2%
@ 31/12/04 11:30
↓:↓ ↑:↑
Exit
```

## 8.2 Failed Calibration

If calibration has failed, the GLP function will reset the date and time to zero. The **WP-88** still shows the results of the last successful calibration. For example:

```
Lo Zero 1.0NTU
@ 00/00/00 00:00
```

```
Hi Span 100.2%
@ 00/00/00 00:00
```

Note that these calibration values are still used if further measurements are taken without recalibrating.

## 8.3 Printing GLP Information to the RS232 Port

The GLP information stored in the instrument's memory can be sent to a printer or PC via the RS232 port.

Switch the meter on.

1. Ensure that the **WP-88** RS232 cable is connected to the instrument and to the printer or PC.
2. Send the GLP information to the RS232 port  
(**Menu**) → **F4:Setup** → **F3:GLP** → **F3:Print**)
3. The GLP information is sent to the RS232 port in formatted ASCII text. For example...

```
WP88 V1.1 T1234 Probe V1.1 T4321 @ 31/12/04 12:00
Turbidity Low Zero= 1.0NTU @ 31/12/04 11:10
Turbidity Low Span= 100.2% @ 31/12/04 11:20
Turbidity High Zero= 1.NTU @ 31/12/04 11:30
Turbidity High Span= 100.2% @ 31/12/04 11:40
ENDS
```

#### 8.4 Instrument Serial Number

In case the serial number that is fitted to the rear of the **WP-88** is removed or becomes illegible, it is also available on the **WP-88** display.

- The serial number is displayed at turn-on, for example...

```
WP88 V1.1 T1234  
Turbidity, Temp.
```

where **T1234** is the serial number.

- The serial number is displayed when recalling the GLP information (section 8.1).
- The serial number is included on the printout of GLP information (section 8.3).

#### 8.5 Additional GLP Features

Another GLP requirement is to record the date and time of every reading. The **WP-88** does this for you when readings are recorded either with the Notepad function (section 9) or the Automatic Logging function (section 10).

## 9. Notepad Function

### 9.1 Recording Readings into the Notepad

To record readings into the Notepad memory:

1. Press **F1** in normal display mode. The display should now look like this:

```

900.NTU  25.0°C
F1: 1    12:00:00

```

2. If you now press **F1**, the Turbidity, Temperature, Date and Time will be recorded into the Notepad, and labelled as reading number 1.
3. Repeat steps 1 & 2 as often as required. The maximum number of readings that can be stored in the Notepad is 2400.

### 9.2 Recalling Records from the Notepad

To recall records from the Notepad onto the **WP-88** display:

1. Select the Notepad menu (**Menu** → **F2:Notepad**).
2. Select **F1:Recall** from the menu.
3. Record number 1 is now displayed, for example...

```

900.NTU  25.0°C
# 1      F2:Clock

```

4. Press **F2** to alternatively display the date and time or the data for this record.  
 Press **▲** to move forward through the records.  
 Press **▼** to move backward through the records.  
 Press and hold the **▲** or **▼** keys to roll rapidly through the readings.

### 9.3 Erasing Records from the Notepad

To erase all records from the Notepad:

1. Select the Notepad menu (Menu → **F2:Notepad**).
2. Select **F2:Erase** from the menu.
3. The **WP-88** now asks if you are sure that you wish to erase all records...

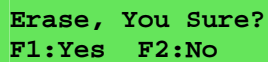

Erase, You Sure?  
F1:Yes F2:No

4. Press (F1) to erase all records from the Notepad.  
Press (F2) to quit without erasing the records from the Notepad.

### 9.4 Printing Records from the Notepad to the RS232 Port

1. Connect one end of the RS232 cable to the **Charger/RS232** socket of the **WP-88**. The charger, optional solar panel, or optional car battery lead can be connected into the spare socket on the cable for long term use, if required.
2. Connect the other end of the RS232 cable to an RS232 Printer, or to COM1 or COM2 of a PC.
3. Ensure that the baud rate for the printer or PC and the **WP-88** are the same.

If necessary, alter the baud rate of the **WP-88** (see section 11.1).

The **WP-88** uses XON/XOFF protocol. Ensure that the printer is set accordingly.

4. Select the Notepad menu (Menu → **F2:Notepad**).
5. Select **F3:Print** from the menu.  
Printing starts as soon as (F3) is pressed. The display shows the word "**Printing**" until printing is completed.



## 10. Automatic Datalogging

The **WP-88** can automatically log records into the Notepad. First the logging period must be programmed, then automatic logging can be started and stopped as required.

1. Select the Program menu (Menu) → **F2:Notepad** → **F4:Prog.**)
2. The display should now look like this...

```
>00< F1:Min F2:Sec
↑↓:Period F3:Hr
```

3. Use the ▲ and ▼ keys to set the period at which the **WP-88** will automatically log records.
4. When the logging period has been correctly set, select whether this period is in minutes, seconds or hours.
  - Press F1 to save the period as minutes.
  - Press F2 to save the period as seconds.
  - Press F3 to save the period as hours.

eg: If the period was set to **05**, followed by F2, then the **WP-88** will automatically log a record every 5 seconds.
5. The **WP-88** will ask if the records are to be logged into the Notepad, or sent directly to the RS232 port.
  - Press F1 to log records into the Notepad (maximum of 2400 readings).
  - Press F3 to send records directly to the RS232 port.
6. The automatic logging function is now programmed, and can be started and stopped as required.

*Continued over the page...*

7. To start automatic logging, press **F3** in normal display mode. If the **WP-88** is logging into the Notepad, the display will look like this:

```
900.NTU 25.0°C  
Log# 1 12:00:00
```

The log number will increment and the **WP-88** will beep each time a reading is recorded.

If the **WP-88** is sending records directly to the RS232 port, the display will look like this...

```
900.NTU 25.0°C  
Sending 12:00:00
```

The **WP-88** will beep each time a record is sent to the RS232 port.

8. Press **F3** to stop automatic logging.

**Notes:**

1. The clock must be set before the **WP-88** will allow automatic logging to start. The message "**Clock Not Set**" is displayed if the clock is not set.
2. The Battery Saver function (section 12) is disabled while the meter is in Automatic Datalogging mode, to stop the meter switching off while logging data. Even when the memory is full and the meter stops logging, the Battery Saver function is still disabled. This allows the data to be downloaded and the memory to be reset remotely.





## 11. RS232 Port

### 11.1 Setting the Baud Rate

1. Select the RS232 Set-up menu (  → **F4:Setup** → **F3:Baud**).
2. The available baud rates are listed on the display.

```
F1:300  F2:1200
>F3:9600 F4:19200
```

The arrow shows the current selection.

3. Press  to select 300 baud  
 Press  to select 1200 baud  
 Press  to select 9600 baud.  
 Press  to select 19200 baud.  
 Press  to quit and retain the current setting.

### 11.2 Sending Readings to the RS232 Port

Press  to instantly send readings to the RS232 port whenever the **WP-88** is in normal run mode. This function is disabled if the automatic logging period is set to greater than zero (see section 10).

Records can be sent directly to the RS232 port rather than stored in memory during automatic datalogging. See section 10 for details.

### 11.3 RS232 Configuration

The **WP-88** RS232 configuration is 8 bits, No Parity, 1 Stop Bit, XON/XOFF Protocol.

### 11.4 Communication and Statistical Software

Communication between the **WP-88** and a PC can be handled with any RS232 communication software. **WinTPS** RS232 communication software for Windows<sup>®</sup> 95 and later is optionally available (part number 130086).

Once the data is saved to disk, the next problem is how to use it. The data sent by the **WP-88** is formatted in fixed-width columns that can be imported by programs such as Microsoft<sup>®</sup> Excel<sup>®</sup> and Lotus 123<sup>®</sup>.

Information on how to use the software and import data is provided in the manual provided with the **WinTPS** CD-ROM and in section 11.8.

**11.5 Commands**

The following commands can be sent from a PC to the **WP-88**. Note that <cr> denotes carriage return and <lf> denotes a line feed.

Action	Command	Notes
Request current data	?D<cr>	Returns the current Turbidity, Temperature, date and time from the <b>WP-88</b> . The log number returned is set to Zero.
Request logged data	?R<cr>	Returns all logged records from the <b>WP-88</b> memory. The data ends with the message <b>ENDS&lt;cr&gt;</b>
Erase logged data	?E<cr>	Erases all logged records from the <b>WP-88</b> memory. Returns the message <b>ERASED&lt;cr&gt;</b> to confirm that the records have been erased.
Request status information	?S<cr>	Returns the model name, firmware version number, instrument serial number and number of logged readings in memory, eg: <b>WP88♦♦V1.1♦T1234♦2400&lt;cr&gt;</b> , where ♦ are spaces. Note that the number of logged readings is right-justified.
Request GLP information	?G<cr>	Returns all calibration GLP information, plus the instrument model and current date (see section 11.6 for data format and handshaking).

## 11.6 Data Format

Data is returned to the RS232 Port by the **WP-88** in the following format. A “•” shown anywhere in this section denotes one space.

**LLLL•TTTTTNTU•ttttttoC•dd/mm/yy•hh:mm:ss**

**LLLL** is the Log Number. Maximum 4 characters, right justified. The **WP-88** sends a Zero for instant readings (section 11.2)

**TTTTTT** is Turbidity data. 6 characters, right justified.

**NTU** is the Turbidity unit description (3 characters).

**tttttt** is Temperature data, 6 characters, right justified.

**oC** is the Temperature unit description (2 characters).

**dd/mm/yy** is the date, month and year data.

**hh:mm:ss** is the hours, minutes and seconds data.

### Notes

1. When requested by a PC with the ?D or ?R commands (section 11.5), the data is terminated with a carriage return.
2. When the data is sent by the **WP-88** using the Print function (section 9.4) or the Send function (section 11.2) the data ends with a carriage return and a line feed.
3. When the sensor is not connected and the **WP-88** is displaying the message “**No Probe**”, the Turbidity and Temperature data are replaced with spaces in the serial data string.

### 11.7 GLP Data Format

GLP information is returned as 4 lines terminated by a carriage return. When using the "?G" command (section 11.5), the computer must respond with a character after receiving each line. For example...

```
WP88 V1.1 T1234 Probe V1.1 T4321 @ 31/12/04 12:00
Turbidity Low Zero= 1.0NTU @ 31/12/04 11:10
Turbidity Low Span= 100.2% @ 31/12/04 11:20
Turbidity High Zero= 1.NTU @ 31/12/04 11:30
Turbidity High Span= 100.2% @ 31/12/04 11:40
ENDS
```

## 11.8 Importing Data into Microsoft Excel

The following procedure details the method for importing a **WP-88** text data file into Microsoft® Excel®.

1. Start Microsoft® Excel® and select **F**ile → **O**pen
2. In the “Files of **t**ype:” pull-down box, choose “Text Files (\*.prn; \*.txt; \*.csv)”.
3. Navigate to the folder where your data file is stored and double-click it to start the Text Import Wizard.

**Note:** The default data folder for the WinTPS software is “C:\My Documents\WinTPS”.

4. In step 1 of the Text Import Wizard select “Fixed **w**idth”, as per the sample screen below, then press “Next >”.

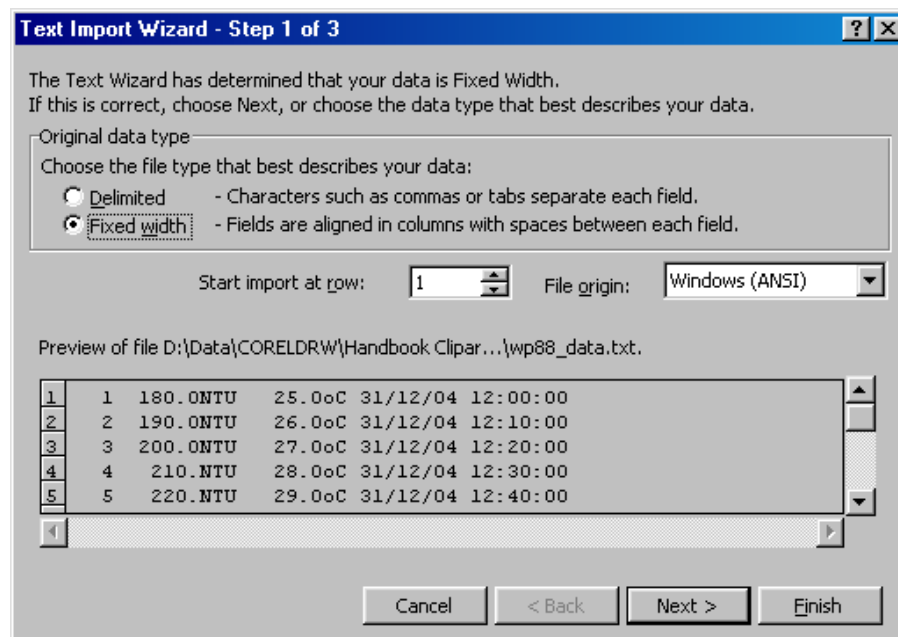

*Continued over the page...*

- Step 2 of the Text Import Wizard allows you to select the points at which each data field will break into a new column. The sample screens below show where TPS recommends the breaks be inserted. Please note that the date and time are placed at the beginning of each line if WinTPS was used to download the data from the instrument.

Press “Next >” after the column breaks have been inserted.

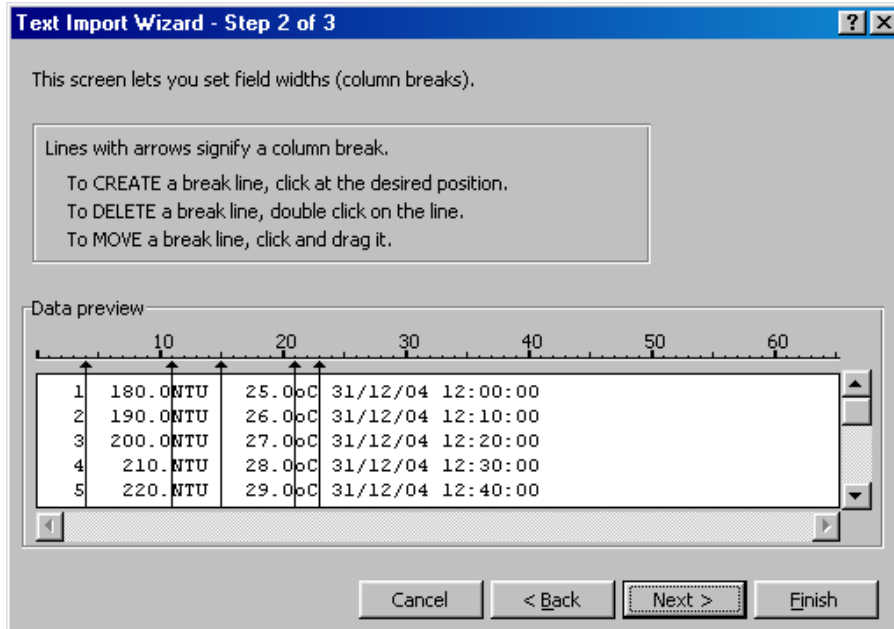

- Simply press “Finish” at step 3 of the Text Import Wizard. TPS recommends that the data format for each column be set once the data is in spreadsheet format.

For help on formatting the data columns, charting, graphing or other operations please consult the Microsoft® Excel® help file. Alternatively please contact TPS and we will try to provide further assistance.



## 12. Battery Saver Function

The **WP-88** is equipped with a battery saver function. If no button has been pressed for five minutes, the unit beeps and flashes the display for 20 seconds, and then shuts off. This function can be switched off for continuous use.

To enable or disable the battery saver function:

1. Switch the meter on.
2. Select Battery Saver Set-up (Menu) → **F4:Setup** → **F1:Batt**).
3. The battery saver menu is now displayed.

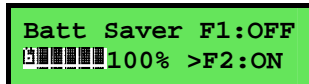

The arrow indicates the current selection.

The bar graph and percentage indicate the approximate level of charge in the battery.

4. Press (F1) to disable the battery saver function for continuous use.  
Press (F2) to enable the battery saver function. The meter will switch itself off if no key has been pressed for five minutes.  
Press (Menu) to quit the battery saver menu and retain the current setting.

### Notes:

1. For troubleshooting purposes, the battery volts can also be displayed in the battery saver menu. Press (F3) to display battery volts.
2. The  symbol flashes when the battery volts drops below 5.60 volts. At 5.00 volts the meter turns itself off.
3. The Battery Saver function is disabled while the meter is in Automatic Datalogging mode (section 10), to stop the meter switching off while logging data. Even when the memory is full and the meter stops logging, the Battery Saver function is still disabled. This allows the data to be downloaded and the memory reset remotely.

### **13. Recharging the Battery**

The  symbol flashes when the battery drops below 5.60 volts. The battery should be recharged at this point. If the battery is not recharged, the **WP-88** will switch itself off when the battery drops below 5.00 volts.

To recharge the battery...

1. Plug the battery charger, solar panel, or car cigarette lighter adaptor into the **Charger/RS232** socket. **DO NOT** plug into the **Temperature** socket, as this will damage the **WP-88**.
2. Charge for approximately 8 hours for full capacity. The **WP-88** has special circuitry to prevent overcharging, so the charger can be used continuously.
3. To ensure optimum battery life and capacity, the **WP-88** should only be charged once the  symbol starts to flash.

## 14. Clock Function

### 14.1 Setting the Clock













1. Select the Clock Set-up menu (  → **F4:Setup** → **F2:Clock**).
2. The display now shows the current date and time. The cursor starts at the day. For example...

```

31/12/04 12:00
F1:< F2:> ↑↓:Set

```

Press the  and  keys until the day is correct.

3. Press  to move to the month. Press the  and  keys until the month is correct.
4. Press  to move to the year. Press the  and  keys until the year is correct.
5. Press  to move to the hour. Press the  and  keys until the hour is correct.
6. Press  to move the cursor to the minutes. Press the  and  keys until the minutes are correct.
7. Check that the date and time are correct.

Press  to save the settings.

If any changes are needed, press the  key to move left to the desired position.

Press  to quit without resetting the clock.

### Notes

1. The **WP-88** does not test for a valid day of the month when setting the clock (eg: attempting to enter 31/02/02 is not corrected).
2. The **WP-88** does test for leap years.

### 14.2 Displaying or Hiding the Clock

The date and time are normally displayed along with the Turbidity and Temperature readings. Press  in normal display mode to alternatively display or hide the clock.

**15. Initialising the WP-88**

If the calibration settings of the **WP-88** exceed the allowable limits, the unit may need to be initialised to factory default values.

To initialise the **WP-88**:

1. Switch the **WP-88** off.
2. Press and hold the  key while switching the **WP-88** back on.
3. The following screen is displayed...

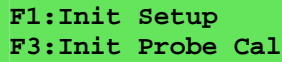

F1:Init Setup  
F3:Init Probe Cal

Press  to initialise the instrument user settings to factory defaults, as per the following table...

User Setting	Default Value	Handbook Section
Calibration Standards	Low Standard : 90.0 NTU High Standard : 900 NTU	5.1
Battery Saver	On	12
Baud Rate	9600	11.1
Auto Logging Period	Zero	10
Logged Data	Erased	9.3

Press  to initialise the Turbidity sensor calibration data to factory defaults. The calibration data is stored within the Turbidity sensor itself.

Note the “ \* “ in place of the decimal point, indicating that the Turbidity sensor requires recalibration.

4. The meter will return to normal display mode. Re-enter any of the settings or re-calibrate the instrument as required.

## 16. Troubleshooting

### 16.1 General Errors

<b>Error Message</b>	<b>Possible Causes</b>	<b>Remedy</b>
<b>Factory Cal. Failed</b>  <i>then:</i>  <b>See Handbook</b>	The EEPROM chip which contains the factory calibration information has failed.	The unit must be returned to TPS for service.
<b>Memory Failed Calibration Lost</b>  <i>then:</i>  <b>Initialized MUST ReCalibrate</b>	User calibration settings have been lost or corrupted.	Re-calibrate the instrument. A full 2-point calibration will be required
Flashing  symbol.	Battery is below 5.60 volts.	Recharge the battery. Note that the unit will switch itself off when the battery falls below 5.00 volts.
Meter displays the word <b>OFF</b> , and switches off.	Battery is below 5.00 volts.	Recharge the battery. If this fails, check the charger. If charger OK, replace the battery.
Meter will not turn on.	Battery is exhausted.	Recharge the battery. If this fails, check the charger. If charger OK, replace the battery.
Battery does not charge up when charger is connected.	<ol style="list-style-type: none"> <li>1. Faulty battery charger.</li> <li>2. Faulty battery.</li> </ol>	<ol style="list-style-type: none"> <li>1. Connect the charger and switch the power on.</li> <li>2. Display the battery volts in the battery saver menu (see section 12).</li> <li>3. If the battery volts are increasing then the charger is OK. If the battery volts do not increase, then the charger is faulty.</li> <li>4. Replace the charger or the battery, as required.</li> </ol>

**16.2 Turbidity Troubleshooting**

<b>Symptom</b>	<b>Possible Causes</b>	<b>Remedy</b>
Turbidity cannot be calibrated, or readings inaccurate	<ol style="list-style-type: none"> <li>1. Turbidity standard is incorrect.</li> <li>2. Turbidity sensor is dirty.</li> <li>3. Turbidity sensor is not immersed correctly.</li> </ol>	<p>Check Turbidity standards. Zero calibration must be performed in fresh Distilled water. Check that the Turbidity standard has been correctly entered (section 5.1).</p> <p>Clean tip of Turbidity sensor with a clean, soft cloth. Avoid scratching the sensing surface.</p> <p>Turbidity sensor must be at least 30mm above the floor of the sample vessel.</p>
Meter displays " <b>No Probe</b> " when the sensor is connected.	<ol style="list-style-type: none"> <li>1. Faulty cable</li> <li>2. Faulty sensor</li> </ol>	<p>Repair or replace the detachable cable.</p> <p>Repair or replace the sensor.</p>

## **17. Warranty**

TPS Pty. Ltd. guarantees all instruments and sensors to be free from defects in material and workmanship when subjected to normal use and service. This guarantee is expressly limited to the servicing and/or adjustment of an instrument returned to the Factory, or Authorised Service Station, freight prepaid, within twelve (12) months from the date of delivery, and to the repairing, replacing, or adjusting of parts which upon inspection are found to be defective. Warranty period on rechargeable batteries and sensors is three (3) months.

There are no express or implied warranties which extend beyond the face hereof, and TPS Pty. Ltd. is not liable for any incidental or consequential damages arising from the use or misuse of this equipment, or from interpretation of information derived from the equipment.

Shipping damage is not covered by this warranty.

### **PLEASE NOTE:**

A guarantee card is packed with the instrument or sensor. This card must be completed at the time of purchase and the registration section returned to TPS Pty. Ltd. within 7 days. No claims will be recognised without the original guarantee card or other proof of purchase. This warranty becomes invalid if modifications or repairs are attempted by unauthorised persons, or the serial number is missing.

### **PROCEDURE FOR SERVICE**

If you feel that this equipment is in need of repair, please re-read the manual. Sometimes, instruments are received for "repair" in perfect working order. This can occur where batteries simply require replacement or re-charging, or where the sensor simply requires cleaning or replacement.

TPS Pty. Ltd. has a fine reputation for prompt and efficient service. In just a few days, our factory service engineers and technicians will examine and repair your equipment to your full satisfaction.

To obtain this service, please follow this procedure:

Return the instrument AND ALL SENSORS to TPS freight pre-paid and insured in its original packing or suitable equivalent. INSIST on a proof of delivery receipt from the carrier for your protection in the case of shipping claims for transit loss or damage. It is your responsibility as the sender to ensure that TPS receives the unit.

Please check that the following is enclosed with your equipment:

- **Your Name and daytime phone number.**
- **Your company name, ORDER number, and return street address.**
- **A description of the fault. (Please be SPECIFIC.)**  
**(Note: "Please Repair" does NOT describe a fault.)**

Your equipment will be repaired and returned to you by air express where possible.

For out-of-warranty units, a repair cost will be calculated from parts and labour costs. If payment is not received for the additional charges within 30 days, or if you decline to have the equipment repaired, the complete unit will be returned to you freight paid, not repaired. For full-account customers, the repair charges will be debited to your account.

- **Always describe the fault in writing.**
- **Always return the sensors with the meter.**