

Congratulations !

Your new **microCHEM-Sal** transmitter module is a simple, lower power device for interfacing a Salinity/TDS sensor with datalogging and process control equipment. The industry standard 0 to 1 V DC and 0 to 5 V DC outputs ensure that the **microCHEM-Sal** is compatible with most such devices.

The **microCHEM-Sal** is a breeze to operate. This manual has been designed to help you get started, and also contains some handy application tips. If at any stage you require assistance, please contact either your local TPS representative or the TPS factory in Brisbane.

The manual is divided into the following sections:

1. Table of Contents

Each major section of the handbook is clearly listed. Sub-sections have also been included to enable you to find the information you need at a glance.

2. Introduction

The introduction has a diagram and explanation of the display and controls of the **microCHEM-Sal**. It also contains a full listing of all of the items that you should have received with the unit. Please take the time to read this section, as it explains some of items that are mentioned in subsequent sections.

3. Main Section

The main section of the handbook provides complete details of the **microCHEM-Sal**, including operating modes, calibration, troubleshooting, specifications, and warranty terms.

4. Appendices

Appendices containing background information and application notes are provided at the back of this manual.

TPS Pty Ltd

4 Jamberoo Street
Springwood, Brisbane,
Australia, 4127

Phone : (07) 32 900 400
International : 61 7 32 900 400
Fax : (07) 3808 4871
International : 61 7 3808 4871
Email : tps@tps.com.au
Web Site : www.tps.com.au

microCHEM-Sal Transmitter Module

Handbook Version : 1.02
Date : 23-Nov-2006
Author : AB

Contents

- 1. Introduction 3**
 - 1.1 Unpacking Information 3
 - 1.2 Specifications 4
- 2. Installation and Set-up 5**
 - 2.1 Connection and Configuration Diagram 5
 - 2.2 Mounting the Enclosure 6
 - 2.3 Mounting the Sensors 6
 - 2.4 Terminal Connections 7
 - 2.5 Selecting 0 to 1 V DC or 0 to 5 V DC Output 7
- 3. Calibration 8**
 - 3.1 Calibration Procedure 8
 - 3.2 Calibration Notes 9
 - 3.3 Calibration Data 9
- 4. Troubleshooting..... 10**
 - 4.1 Instrument Function Troubleshooting..... 10
 - 4.2 Salinity/TDS Troubleshooting 10
- 5. Warranty..... 12**
- 6. Appendices 14**
 - 6.1 Re-setting the Measurement Range 14
 - 6.2 Care, Cleaning and Maintenance of Salinity/TDS Electrodes 15

1. Introduction

1.1 Unpacking Information

Before using your new **microCHEM-Sal**, please check that the following accessories have been included:

	Part No
1. microCHEM-Sal Transmitter Module.....	112146
2. Mounting feet, kit of 4, complete with screws	NRMICRO
3. microCHEM-Sal Handbook.....	130050
4. Salinity/TDS standard to suit specified range, 200mL	

Salinity/TDS Sensors...

1. k=0.1 GK Series Salinity/TDS Sensor, 5m	112205
2. k=1.0 GK Series Salinity/TDS Sensor, 5m	112206
3. k=10 GK Series Salinity/TDS Sensor, 5m	112207

1.2 Specifications

Ranges

k=0.1 Sensor 0 to 10.00 ppM, 0 to 100.0 ppM, 0 to 1000 ppM

k=1.0 Sensor 0 to 100.0 ppM, 0 to 1000 ppM, 0 to 10.00 ppK

k=10 Sensor 0 to 1000 ppM, 0 to 10.00 ppK, 0 to 100.0 ppK

Resolution $\pm 1\text{mV}$ (0 – 1 V DC Output) or $\pm 5\text{mV}$ (0 – 5 V DC Output)Accuracy $\pm 1\text{mV}$ (0 – 1 V DC Output) or $\pm 5\text{mV}$ (0 – 5 V DC Output)Linearity $\pm 1\text{mV}$ (0 – 1 V DC Output) or $\pm 5\text{mV}$ (0 – 5 V DC Output)Repeatability $\pm 1\text{mV}$ (0 – 1 V DC Output) or $\pm 5\text{mV}$ (0 – 5 V DC Output)Ambient Drift..... $<0.02\%$ / $^{\circ}\text{C}$ Long term drift..... $<0.1\%$ per yearZero Range..... $\pm 5\%$

Span Range 70 to 130%

Temperature Compensation Automatic, 0 to 100.0 $^{\circ}\text{C}$

Enclosure Polycarbonate, waterproof to IP65

Analogue Outputs 0 to 1 V DC
or 0 to 5 V DC

Isolation Galvanic isolation of sensor input

Power 12V DC, approx 10mA

Dimensions Enclosure : 125 x 85 x 56 mm
PCB only : 115 x 77 mm
(82 x 58 mm mounting hole
centres)Mass Instrument only: Approx 250 g
Full Kit : Approx 1.0 kgOperating Environment: Temperature : 0 to 45 $^{\circ}\text{C}$
Humidity : 0 to 95 % R.H.

2. Installation and Set-up

2.1 Connection and Configuration Diagram

The diagram below is provided as a reference for the terminal connections, configuration jumpers and user-adjustable trimmers that are discussed throughout this section.

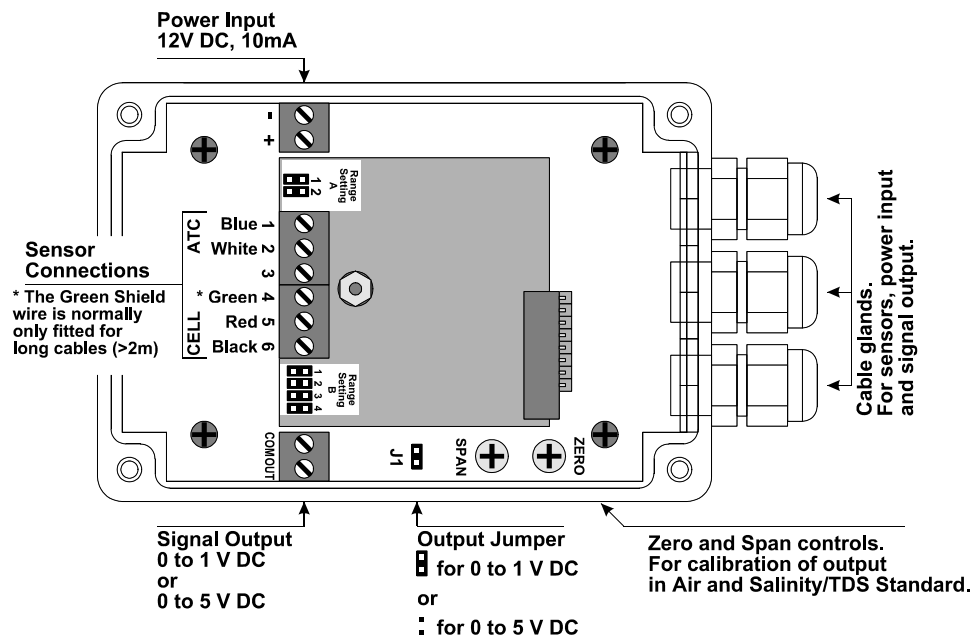

2.2 Mounting the Enclosure

The **microCHEM-Sal** can be mounted directly onto a wall or into a separate enclosure using the mounting kit supplied. Please use the screws supplied to ensure that the waterproof integrity of the enclosure is not compromised.

2.3 Mounting the Sensors

Mounting the sensor is a very important aspect of the installation, and is often done incorrectly. In automatic control situations, the sensor should always be mounted as close as possible to the injection point. This will cause the sensor to detect the added chemicals or water immediately, and shut the addition off until mixing has taken place. For in-line mounting, it is important that injection is upstream. Additionally, the line must be run through a mixing chamber, such as a large drum, to ensure that the injected chemical or water has mixed in properly by the time the solution flows past the sensor. There must always be adequate flow of fresh sample past the sensor for accurate monitoring. The diagrams below show typical mounting arrangements for “dip” mounting and in-line mounting.

Dip Mounting

1. Injection point close to sensor.
2. Continuous stirring.

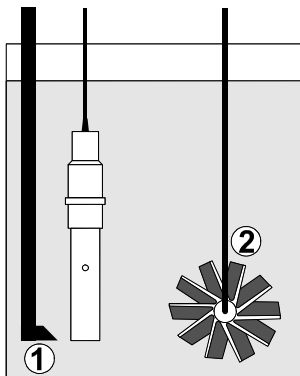

In-line Mounting

1. Injection point upstream from and close to sensor.
2. Mixing container after injection and before sensor.
3. A flow-through assembly for in-line mounting is available from TPS.

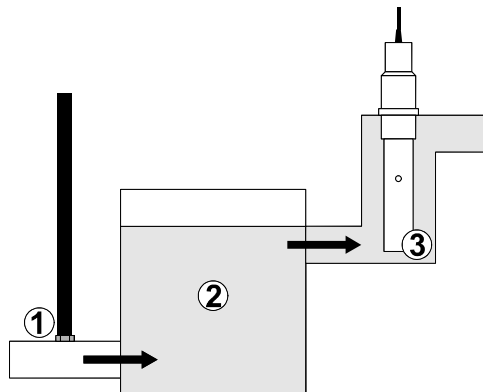

2.4 Terminal Connections

Terminal No.	Connection	Colour
Sensor Connections		
1	Salinity/TDS Sensor ATC	Blue
2	Salinity/TDS Sensor ATC	White
3	No Connection	
4	Shield (if fitted to cable)	Green or Braid
5	Salinity/TDS Sensor Cell	Red
6	Salinity/TDS Sensor Cell	Black
Power Input Connections		
-	Negative of 12V DC Input	Customer-defined
+	Positive of 12V DC Input	Customer-defined
Signal Output Connections		
COM	Common of voltage output	Customer-defined
OUT	Positive of voltage output	Customer-defined

2.5 Selecting 0 to 1 V DC or 0 to 5 V DC Output

1. Locate the jumper labelled **J1** on the main circuit board.
2. Set **J1** to closed to select 0 to 1 V DC output.
3. Set **J1** to open to select 0 to 5 V DC output.

0 to 1 V DC



0 to 5 V DC



Note

When setting **J1** to open, we recommend that it is fitted to one of the pins. This is a safe place to keep it, in case the **microCHEM-Sal** needs to be reset for 0 to 1 V DC output in the future.

3. Calibration

3.1 Calibration Procedure

1. Switch the **microCHEM-Sal** on.
2. Ensure that the Salinity/TDS sensor is correctly connected (see section 2.4).
3. For the GK-1 sensor (part no 112206), ensure that the white protective cover is fitted with the vent hole towards the cable end of the sensor.
4. Rinse the Salinity/TDS sensor in distilled water and blot dry.

Zero Calibration

5. Shake the Salinity/TDS sensor dry and hang it in air. **DO NOT** wipe the platinised platinum electrode surface, as this will remove the platinum-black layer.
6. When the reading has stabilised, adjust the **ZERO** control until the output is exactly 0 mV.

Span Calibration

7. Place the Salinity/TDS sensor into a small sample of Salinity/TDS standard. A suitable standard should be chosen for the display range of the unit.
9. For GK-1 (part no 112206) and GK-10 (part no 112207) sensors, ensure that they are immersed at least to the vent hole in the white plastic cover. The GK-0.1 (part no 112205) sensor does not have a cover, so it should be immersed to the large thread (see diagrams below).

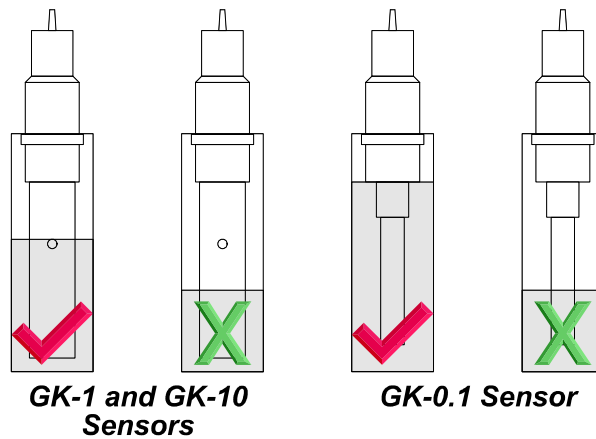

10. When the reading has stabilised, adjust the **SPAN** control until the output corresponds to the value shown in the Calibration Data table in section 3.3.

11. Rinse the Salinity/TDS sensor in distilled water and blot dry.
12. The **microCHEM-Sal** is now calibrated and ready for Salinity/TDS measurements.

3.2 Calibration Notes

1. The Zero calibration is quite stable long term, and only needs to be performed monthly as a routine check. In applications where the sensor can become dirty or coated with oils etc., a Zero calibration may need to be done weekly.
2. A Span calibration should be performed at least weekly. Of course, more frequent calibration will result in greater confidence in results.

3.3 Calibration Data

The following table details the output for Salinity/TDS standards available from TPS to suit the ranges of the **microCHEM-Sal**. Other Salinity/TDS standards may be used, in which case you will need to calculate the output of your **microCHEM-Sal** for the standard being used.

Range	Standard	
	Output 0 to 1 V	Output 0 to 5 V
0 to 10 ppM	No standard available for this range.	
0 to 100 ppM	69.5 ppM	
	695 mV	3475 mV
0 to 1000 ppM	900 ppM	
	900 mV	4500 mV
0 to 10 ppK	8.00 ppK	
	800 mV	4000 mV
0 to 100 ppK	36.0 ppK	
	360 mV	1800 mV

4. Troubleshooting

4.1 Instrument Function Troubleshooting

Symptom	Possible Causes	Remedy
Incorrect analogue output signal.	<ol style="list-style-type: none"> J1 Output Jumper incorrectly set for required output. Instrument is faulty. 	<p>Check that the J1 Output Jumper is correctly set for 0 to 1 V DC or 0 to 5 V DC output, as per requirements. Adjust if necessary (see section 2.5).</p> <p>Return to TPS for repair.</p>

4.2 Salinity/TDS Troubleshooting

Symptom	Possible Causes	Remedy
Zero calibration fails (insufficient range with ZERO control).	<ol style="list-style-type: none"> Electrode has Zero error. Sensor is faulty. 	<p>Thoroughly rinse electrode in distilled water and allow to completely dry in air before attempting zero calibration.</p> <p>If instrument does not calibrate at Zero with electrode disconnected, then the instrument is faulty.</p> <p>Replace sensor.</p>
Standard calibration fails, reading is too low and cannot be adjusted high enough.	<ol style="list-style-type: none"> Electrode is not immersed deeply enough. Electrode may have a build-up of dirt or oily material on electrode wires. Platinum-black coating has worn off. Standard solution is inaccurate. Electrode is faulty. 	<p>Immerse electrode at least to the vent hole in the white plastic cover.</p> <p>Clean electrode, as per the instructions detailed in section 6.2.2.</p> <p>Electrode requires replatinisation.</p> <p>Return to the factory, or see details in section 6.2.3.</p> <p>Replace standard solution.</p> <p>Return electrode to factory for repair or replacement.</p>

Continued next page...

Salinity/TDS Troubleshooting, continued...

Standard calibration fails, reading is too high and cannot be adjusted low enough.	<ol style="list-style-type: none"> 1. White protective cover is not fitted (GK-1 sensor). 2. Standard solution is inaccurate. 3. Electrode may have a build-up of conductive material, such as salt. 4. Electrode is faulty. 	<p>The white protective cover MUST be fitted for correct readings for GK-1 sensor.</p> <p>Replace standard solution.</p> <p>Clean electrode, as per the instructions detailed in section 6.2.2.</p> <p>Return electrode to factory for repair or replacement.</p>
Inaccurate readings, even when calibration is successful.	<ol style="list-style-type: none"> 1. Electrode may have a build-up of dirt or oily material on electrode wires. 2. Platinum-black coating has worn off. 	<p>Clean electrode, as per the instructions detailed in section 6.2.2.</p> <p>Electrode requires replatinisation.</p> <p>Return to the factory, or see details in section 6.2.3.</p>
Readings drift.	<ol style="list-style-type: none"> 1. Electrode may have a build-up of dirt or oily material on electrode wires. 	<p>Clean electrode, as per the instructions detailed in section 6.2.2.</p>
Readings are low or near zero.	<ol style="list-style-type: none"> 1. Electrode may have a build-up of dirt or oily material on electrode wires. 2. Electrode is not immersed deeply enough. 3. Electrode is faulty. 	<p>Clean electrode, as per the instructions detailed in section 6.2.2.</p> <p>Immerse electrode at least to the vent hole in the white plastic cover.</p> <p>Return electrode to factory for repair or replacement.</p>

5. Warranty

TPS Pty. Ltd. guarantees all instruments and electrodes to be free from defects in material and workmanship when subjected to normal use and service. This guarantee is expressly limited to the servicing and/or adjustment of an instrument returned to the Factory, or Authorised Service Station, freight prepaid, within twelve (12) months from the date of delivery, and to the repairing, replacing, or adjusting of parts which upon inspection are found to be defective. Warranty period on electrodes is three (3) months.

There are no express or implied warranties which extend beyond the face hereof, and TPS Pty. Ltd. is not liable for any incidental or consequential damages arising from the use or misuse of this equipment, or from interpretation of information derived from the equipment.

Shipping damage is not covered by this warranty.

PLEASE NOTE:

A guarantee card is packed with the instrument or electrode. This card must be completed at the time of purchase and the registration section returned to TPS Pty. Ltd. within 7 days. No claims will be recognised without the original guarantee card or other proof of purchase. This warranty becomes invalid if modifications or repairs are attempted by unauthorised persons, or the serial number is missing.

PROCEDURE FOR SERVICE

If you feel that this equipment is in need of repair, please re-read the manual. Sometimes, instruments are received for "repair" in perfect working order. This can occur where batteries simply require replacement or re-charging, or where the electrode simply requires cleaning or replacement.

TPS Pty. Ltd. has a fine reputation for prompt and efficient service. In just a few days, our factory service engineers and technicians will examine and repair your equipment to your full satisfaction.

TO OBTAIN THIS SERVICE, PLEASE FOLLOW THIS PROCEDURE:

Return the instrument AND ALL SENSORS to TPS freight pre-paid and insured in its original packing or suitable equivalent. INSIST on a proof of delivery receipt from the carrier for your protection in the case of shipping claims for transit loss or damage. It is your responsibility as the sender to ensure that TPS receives the unit.

Please check that the following is enclosed with your equipment:

- **Your Name and daytime phone number.**
- **Your company name, ORDER number, and return street address.**
- **A description of the fault. (Please be SPECIFIC.)**

(Note: "Please Repair" does NOT describe a fault.)

Your equipment will be repaired and returned to you by air express where possible.



















For out-of-warranty units, a repair cost will be calculated from parts and labor costs. If payment is not received for the additional charges within 30 days, or if you decline to have the equipment repaired, the complete unit will be returned to you freight paid, not repaired. For full-account customers, the repair charges will be debited to your account.

- **Always describe the fault in writing.**
- **Always return the sensors with the meter.**

6. Appendices

6.1 Re-setting the Measurement Range

The range of the **microCHEM-Sal** may be re-set using the table of jumper settings shown below. Refer to the diagram in section 2.1 for the location of the **A** and **B** range jumper blocks. Attach spare jumpers off single unused pins for safe storage.

Range	Sensor k Factor		
	k=0.1	k=1.0	k=10
0 to 10 ppM	<p>A</p>  <p>B</p> 	This range not available for k=1.0 sensor.	This range not available for k=10 sensor.
0 to 100 ppM	<p>A</p>  <p>B</p> 	<p>A</p>  <p>B</p> 	This range not available for k=10 sensor.
0 to 1000 ppM	<p>A</p>  <p>B</p> 	<p>A</p>  <p>B</p> 	<p>A</p>  <p>B</p> 
0 to 10 ppK	This range not available for k=0.1 sensor.	<p>A</p>  <p>B</p> 	<p>A</p>  <p>B</p> 
0 to 100 ppK	This range not available for k=0.1 sensor.	This range not available for k=1.0 sensor.	<p>A</p>  <p>B</p> 

6.2 Care, Cleaning and Maintenance of Salinity/TDS Electrodes

6.2.1 Care of Salinity/TDS electrodes

The Salinity/TDS section of the electrode supplied with your **microCHEM-Sal** consists of two platinum wires that are plated with a layer of “platinum-black”. This is quite a soft layer and is required for stable, accurate measurements. In time, the platinum-black layer may wear off in some applications, at which time the electrode will require replatinising (see section 6.2.3). You can help to maintain the platinum-black layer by following these simple rules:

1. **NEVER** touch or rub the electrode wires with your fingers, cloth etc.
2. Avoid using the electrode in solutions that contain a high concentration of suspended solids, such as sand or soil, which can abrade the electrode wires. Filter these types of solutions first, if possible.
3. Avoid concentrated acids. If you must measure acids, remove the electrode immediately after taking the measurement and rinse well with distilled water.

Salinity/TDS electrodes can be stored dry. Ensure that the electrode is stored in a covered container, to avoid dust and dirt build-up.

6.2.2 Cleaning Salinity/TDS of Electrodes

Platinised platinum Salinity/TDS electrodes can only be cleaned by rinsing in a suitable solvent. **DO NOT wipe the electrode wires**, as this will remove the platinum-black layer.

1. Rinsing in distilled water will remove most build-ups of material on the electrode wires.
2. Films of oils or fats on the electrode wires can usually be removed by rinsing the electrode in methylated spirits.
3. Stubborn contamination can be removed by soaking the electrode in a solution of 1 part Concentrated HCl and 10 parts distilled water. The electrode should not be soaked for more than approximately 5 minutes, otherwise the platinum-black layer may start to dissolve.
4. If all of these methods fail, then the last resort is to physically scrub the electrode wires, which will remove the contaminant and the layer of platinum-black. Use only a cloth or nylon scouring pad. **DO NOT USE STEEL WOOL**. The electrode will then need to be cleaned in HCl, as per step 3 and replatinised, as per section 6.2.3.

6.2.3 Replatinising Salinity/TDS Electrodes

There are several ways to replatinise Salinity/TDS electrodes.

1. The simplest way is to return the electrode to the TPS factory. We can fully clean the electrode, replatinise it and test all aspects of its performance.
2. An automatic replatiniser is available from TPS, along with replatinising solution. This will plate the electrodes for the right amount of time at the correct current. Ordering details are as follows:

Automatic Salinity/TDS Electrode Replatiniser	Part No 122160
20mL Platinising Solution (suitable for approx 30 uses)	Part No 122300
3. Salinity/TDS electrodes can be manually replatinised, according to the following procedure:
 - 1) Soak the electrode in a solution of 1 part Concentrated HCl and 10 parts distilled water for approximately 5 minutes.
 - 2) Rinse the electrode well in distilled water.
 - 3) Immerse the electrode in platinising solution to the same level as for calibration (see section 3.1). Platinising solution is available from TPS (part no 122300). Alternatively, platinising solution can be prepared by dissolving 1g of Hydrogen Chloroplatinate (H_2PtCl_6) in 30mL of distilled water, and including about 0.01g of Lead Acetate ($(CH_3COO)_2Pb$) and a drop or two of concentrated HCl.
 - 4) Apply a direct current of 10mA between red and black wires of the electrode cable, as per the diagram below. Reverse the polarity every 30 seconds. After approximately 8 minutes (4 minutes per electrode wire), they should have an even “soot” like appearance. Avoid excess current and this will cause incorrect platinising.
 - 5) After platinising, rinse the electrode well in distilled water.
 - 6) If you have any doubts about any of these steps, then you should consider returning the electrode to the factory. The cost of replatinising is quite low, and you will be guaranteed of the best possible result.