

Congratulations !

You have purchased the latest in Handheld pH-mV-Temperature instrumentation. We trust that your new **MC-80** will give you many years of reliable service.

The **MC-80** is a breeze to operate. This manual has been designed to help you get started, and also contains some handy application tips. If at any stage you require assistance, please contact either your local TPS representative or the TPS factory in Brisbane.

The manual is divided into the following sections:

1. Table of Contents

Each major section of the handbook is clearly listed. Sub-sections have also been included to enable you to find the information you need at a glance.

2. Introduction

The introduction has a diagram and explanation of the display and controls of the **MC-80**. It also contains a full listing of all of the items that you should have received with your **MC-80**. Please take the time to read this section, as it explains some of items that are mentioned in subsequent sections.

3. Main Section

The main section of the handbook provides complete details of the **MC-80**, including operating modes, calibration, troubleshooting, specifications, and warranty terms.

4. Appendices

Appendices containing background information and application notes are provided at the back of this manual.

TPS Pty Ltd
4 Jamberoo Street
Springwood, Brisbane,
Australia, 4127

Phone : (07) 32 900 400
International : 61 7 32 900 400
Fax : (07) 3808 4871
International : 61 7 3808 4871
E-mail : tps@tpssite.com.au

Model MC-80 pH-mV-Temp. Meter

Handbook Version : 2.1
Date : 23/02/99
Author : MS

Contents

1. Introduction	2
1.1 MC-80 Display and Controls.....	2
1.2 Unpacking Information.....	4
1.3 Specifications.....	4
2. Operating Modes	5
2.1 Display Modes.....	5
2.2 Readout Modes.....	5
3. pH Calibration	7
3.1 Calibration.....	7
3.2 Calibration Notes.....	8
3.3 Calibration Messages.....	8
4. mV Calibration	8
5. Temperature Calibration	9
5.1 Temperature Calibration.....	9
5.2 Calibration Notes.....	9
5.3 Calibration Messages.....	9
5.4 Manual Temperature Setting.....	10
6. Battery Saver Function	10
7. Selecting pH6.88 or pH7.00 as the Primary Buffer	11
8. Initialising the MC-80	11
9. Troubleshooting	12
9.1 General Error Messages.....	12
9.2 pH and mV Troubleshooting.....	13
9.3 Temperature Troubleshooting.....	14
10. Warranty	15
11. Appendices	17
11.1 pH Electrode Fundamentals.....	17
11.2 Checking the reference junction of a pH electrode.....	19
11.3 Determining if an instrument or electrode is faulty.....	20
11.4 Instrument software version number.....	20

1. Introduction

1.1 MC-80 Display and Controls

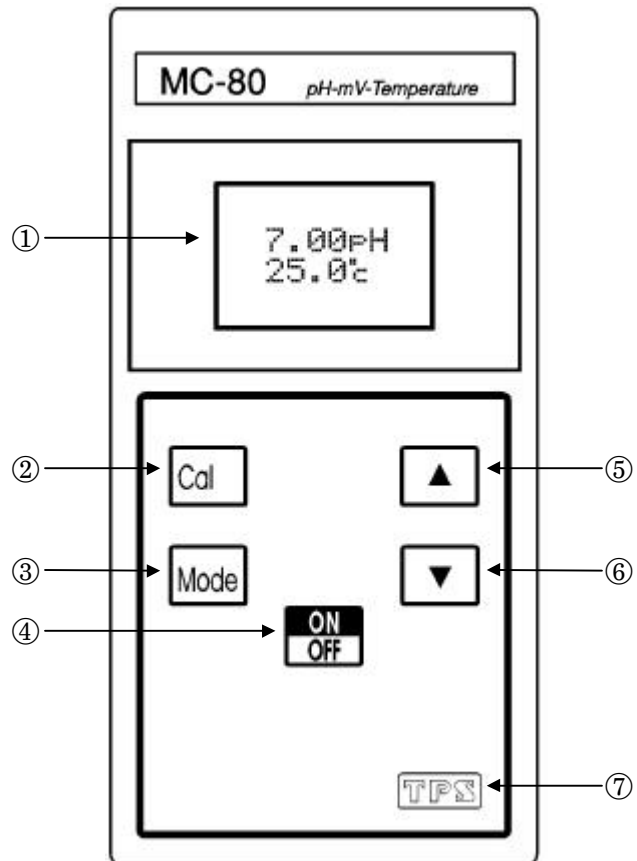

- ① **Display**
16 character alpha-numeric display. Shows pH/mV and temperature simultaneously. A unique “Large Digit” mode nearly doubles the size of the digits. See section 2.1.
User-friendly prompts and error messages are also provided.



- ② 
Used to calibrate pH and temperature, and to set manual temperature compensation value when temperature probe is unplugged. See sections 3.1, 5.1, and 5.4.

Also used to select buffers for automatic buffer recognition. See section 7.



- ③ 
Switches between pH, mV and Temperature modes. See section 2.2.

- ④ 
Switches the **MC-80** on and off.

Hold this key for 3 seconds to invoke the Battery Saver mode. See section 6.

- ⑤  and ⑥ 
These keys toggle the **MC-80** between Large Display mode and Dual Display mode. See section 2.1.

NOTE: The digits in Large Display mode are made by combining the two rows of the display. The result is a small gap approximately half way up the digits.

The  and  keys are also used to set the manual temperature compensation value if the temperature probe is unplugged. See section 5.4.

- ⑦ 
The TPS logo. Your guarantee of **T**echnology, **P**recision and **S**ervice, in electrochemistry.

1.2 Unpacking Information

Before using your new **MC-80**, please check that the following accessories have been included:

	Part No
1. MC-80 pH-mV-Temperature Instrument	121108
2. Combination pH Electrode	121207
3. Temperature/ATC Probe	121265
4. pH6.88 Buffer, 200mL	121306
5. pH4.00 Buffer, 200mL	121381
6. 9V Battery	130026
7. MC-80 Handbook	130050

Options that may have been ordered with your **MC-80**:

1. NiCad Rechargeable battery and charger	130007
2. Hard Plastic Carry Case	130057

1.3 Specifications



Ranges	: 0 to 14.00 pH 0 to ± 1500 mV -10.0 to +120.0 °C
Resolution	: 0.01 pH 1 mV 0.1 °C
Accuracy	: ± 0.01 pH ± 1 mV ± 0.2 °C
Input Impedance	: $> 3 \times 10^{12} \Omega$
Asymmetry Range	: -1.00 to 1.00 pH
Slope Range	: 85.0 to 105.0%
Temperature Compensation	: 0 to 100.0 °C, automatic or manual
Power	: 9V Alkaline Battery for 100 hours operation. Optional NiCad battery/charger pack available.
Dimensions	: 157 x 78 x 35 mm
Mass	: Instrument only : Approx 200g Full Kit : Approx 1.5kg
Environment	Temperature : 0 to 45 °C Humidity : 0 to 90 % R.H.

2. Operating Modes

2.1 Display Modes

The **MC-80** has two display modes:

1. Dual Display mode
2. Large Display mode.

Press the  or  keys to toggle between these two modes.

2.2 Readout Modes

Press the  key to roll through the three readout modes.

In Dual Display mode, the three readout modes are:

1. pH

Displays pH and Temperature readings simultaneously.

eg: **7.00pH**
25.0°C

If the temperature probe is unplugged, the manual temperature setting is displayed with 1°C resolution.

eg: **7.00pH**
 **25°C**

2. mV

Displays mV and Temperature readings simultaneously.

eg: **1000mV**
25.0°C

If the temperature probe is unplugged, the manual temperature setting is **NOT** displayed.

eg: **1000mV**

Note: Temperature compensation does not apply in mV mode.

3. Temperature

Displays just the temperature reading.

eg: **25.0°C**

If the temperature probe is unplugged, the manual temperature setting is displayed with 1°C resolution.

eg:  **25°C**



In Large Display mode, the three readout modes are:

1. **pH**
Displays just the pH reading in large digits.
2. **mV**
Displays just the mV reading in large digits.
3. **Temperature**
Displays just the temperature reading in large digits. If the temperature probe is unplugged, the manual temperature setting is displayed with 1°C resolution.

Note: The decimal point is replaced by a * if a pH or Temperature calibration has failed (see sections 3.1, Calibration and 5.1, Temperature Calibration), if the unit is initialised (see section 8), or if the unit has lost its factory calibration (see section 9.1).

3. pH Calibration

3.1 Calibration

1. Press the  key if the meter is not already switched on.
2. Ensure that you are using the buffers which have been selected for automatic buffer recognition. See section 7 for a detailed explanation.
3. Press the  key until the meter is in pH mode. (See section 2.2, Readout Modes)
4. Plug the pH electrode into the **Sensor** socket and the temperature probe into the **Temp** socket.
5. Ensure that temperature has already been calibrated, or manually set (see sections 5.1 and 5.4). NOTE: If the decimal point in the temperature reading is replaced by a *, then the temperature readout is not calibrated.
6. Remove the wetting cap from the pH electrode.
7. Rinse the pH and Temperature electrodes in distilled water and blot them dry.
8. Place both electrodes into a small sample of pH6.88 (or pH7.00) buffer, so that the bulb and reference junction are both covered. **DO NOT** place the electrodes directly into the buffer bottle. Discard the used buffer after use.
9. When the reading has stabilised, press and hold the  key for 2 seconds to calibrate. If a 1 point calibration has been performed, the * will not be removed until a full 2 point calibration has been performed.
10. Rinse the pH and Temperature electrodes in distilled water and blot them dry.
11. Place both electrodes into a small sample of pH4.00, pH9.23 or pH10.00 Buffer, so that the bulb and reference junction are both covered. **DO NOT** place the electrodes directly into the buffer bottle. Discard the used buffer after use.

NOTE: pH9.23 and pH10.00 buffers are highly unstable. Avoid using these buffers if possible. Discard immediately after use.

When the reading has stabilised, press and hold the  key for 2 seconds to calibrate. The * will now be replaced by a decimal point, if calibration was successful.

12. The **MC-80** is calibrated and ready for use. Simply dip the pH and Temperature sensors into unknown samples for fast, reliable measurements.

3.2 Calibration Notes

1. A 1-point calibration should be performed at least weekly. In applications where the electrode junction can become blocked, such as dairy products, mining slurries etc, a 1-point calibration may have to be done daily.
2. A full 2-point calibration should be performed at least monthly. Of course, more frequent calibration will result in greater confidence in results.
3. All calibration information is retained in memory when the **MC-80** is switched off, even when the battery is removed.
4. The MC-80 displays the value of the pH buffer that it has attempted to recognise at calibration. Ensure that the buffer value displayed corresponds to the buffer that you are using.

3.3 Calibration Messages

1. If a 1-point calibration has been successfully performed, the **MC-80** will display the following message, and then display the asymmetry of the electrode.

eg: **1 Point** then: **Asy**
6.88 OK **0.10 pH**

2. If a 1-point calibration has failed, the **MC-80** will display the following message, then the failed asymmetry value of the electrode.

eg: **1 Point** then: **Asy Hi** or: **Asy Lo**
6.88Fail **1.50 pH** **-1.50 pH**

3. If a 2-point calibration has been successfully performed, the **MC-80** will display the following message, and then the asymmetry and slope of the electrode.

eg: **2 Point** then: **Asy** then: **Slope**
4.00 OK **0.10 pH** **95.0%**

4. If a 2-point calibration has failed, the **MC-80** will display the following message, and then the failed slope value of the electrode.

eg: **2 Point** then: **Slope Hi** or: **Slope Lo** then: **Check**
4.00Fail **130.0%** **70.0%** **Buffers**



4. mV Calibration

The mV section is factory calibrated. There is no user-calibration facility for this mode.

5. Temperature Calibration





The temperature readout must be calibrated or manually set before attempting pH calibration. The decimal point is replaced by a * if the reading is not calibrated.

5.1 Temperature Calibration

1. Press the  key if the meter is not already switched on.
2. Press the  key until the meter is in Temperature mode.
3. Plug the temperature probe (Part No 121265) into the **Temp** socket.
4. Place the probe into a beaker of room temperature water, alongside a good quality mercury thermometer. Stir the probe and the thermometer gently to ensure an even temperature throughout the beaker.
5. When the reading has stabilised, press and hold the  key for 2 seconds.
6. The reading from the probe is now displayed on the top line, and the value you are going to set is on the bottom line.

eg: **25*0 °C**

↑**26.0**↓

7. Press the  and  keys until the bottom line shows the same temperature as the mercury thermometer.
8. Press the  key to calibrate the temperature readout.
Alternatively, press the  key to abort temperature calibration.
9. **Note:** Temperature calibration information is stored in memory when the meter is switched off, even if the battery is removed. Temperature does not need to be recalibrated unless the temperature probe is replaced.



5.2 Calibration Notes

1. Temperature calibration information is stored in memory when the meter is switched off, even if the battery is removed.
2. Temperature does not need to be recalibrated unless the Temperature probe is replaced or the meter is initialised.

5.3 Calibration Messages



1. If a temperature calibration has been successfully performed, the **MC-80** will display the following message and then the offset value of the probe.
eg: **Temp** then: **Offset**
Cal. OK **1.0°C**
2. If a temperature calibration has failed, the **MC-80** will display the following message, and then the failed offset value of the probe.
eg: **Temp** then: **Offset**
Cal.Fail **10.5°C**

5.4 Manual Temperature Setting

1. Press the  key if the meter is not already switched on.
2. Press the  key until the meter is in Temperature mode.
3. Manual temperature setting is only available if the temperature probe is not plugged in.
4. Press and hold the  key for 2 seconds.
5. The display should now look like this:

Man.Temp

↑**25.0**↓

6. Press the  and  keys until the bottom line shows the temperature which you wish to set. This value should be the same as the temperature of the solution you are measuring.



Press the  key to set the temperature.

Alternatively, press the  key to abort manual temperature setting.



6. Battery Saver Function

The **MC-80** is equipped with a battery saver function. If no button has been pressed for five minutes, the unit beeps and flashes the display for 20 seconds, and then shuts off. This function can be disabled for continuous use.

To enable or disable the battery saver function:

1. Press the  key if the meter is not already switched on.
2. With the meter already switched on, press and HOLD the  key for 3 seconds.
3. The display should now look like this:

Either: :ON↑↓ or: :OFF↑↓
9.00V **9.00V**









4. In this mode, use the  or  keys to toggle the battery saver function on or off.

NOTE: The display also shows the battery volts. This gives the operator an idea of how much battery life is remaining. The  symbol flashes when the battery volts drops below 7.50 volts. At 6.00 volts the meter turns itself off.

5. When you have set the battery saver function to the desired position, press the  key to return to normal measurement mode. The setting is kept in memory when the meter is switched off, even if the battery is removed.

7. Selecting Buffers for Auto Buffer Recognition

The **MC-80** is factory set to automatically recognise pH4.00, pH6.88 and pH9.23 buffers. However, some users may prefer to use pH7.00 instead of pH6.88 and pH10.00 instead of pH9.23. The following procedure describes how to set which of these buffers are automatically recognised at calibration.



1. Switch the meter **OFF** with the  key.
2. Press and HOLD the  key while switching the meter back on.
3. Release the  key when the message, “**Select Buffer**” is displayed.
4. The display will now show the currently selected primary buffer.
Use the  or  keys to alternate between pH6.88 and pH7.00 buffers.
5. Press the  key to save the primary buffer.
6. The display will now show the currently selected high pH buffer.
Use the  or  keys to alternate between pH9.23 and pH10.00 buffers (the display shows pH10.0 for the latter but this buffer is stored as pH10.00).
7. Press the  key to save the high pH buffer.
8. The buffer recognition setting is kept in memory when the meter is switched off, even if the battery is removed. The buffers are re-set to pH6.88 and pH9.23 during initialisation.

Note: pH6.88 buffer is a DIN 19266 and NBS Primary-standard pH solution. Its use is highly recommended for the most accurate possible results. If pH7.00 buffer is used, ensure that it is manufactured to 0.01pH accuracy. pH7.00 buffer has a buffer capacity less than half that of pH6.88 buffer and is therefore much less stable.

8. Initialising the MC-80

If the calibration settings of the **MC-80** exceed the allowable limits, the unit may need to be initialised to factory default values. This action may be required if the electrode is replaced.

To initialise the **MC-80**:

1. Switch the **MC-80** off, by pressing the  key.
2. Press and hold the  key while switching the **MC-80** back on.
3. The following messages should be displayed:

Memory then: **You MUST** then: **TPS MC80**
Reset ! **Re-Cal.** **pH mV °c**

4. The meter then displays pH and Temperature. Note that the decimal points have been replaced with a *, to indicate that the unit requires re-calibration.

Note: When the **MC-80** is initialised, the automatically recognised buffers are re-set to pH4.00, pH6.88 and pH9.23. See section 7 if you prefer to use pH7.00 instead of pH6.88 and pH10.00 instead of pH9.23.

9. Troubleshooting

9.1 General Error Messages

Error Message	Possible Causes	Remedy
Factory Cal. Fail See Handbook	The EEPROM chip which contains the factory calibration information has failed.	The unit must be returned to TPS for service. <ul style="list-style-type: none"> • mV & Temperature readings may be up to 10% incorrect. • pH readings will be accurate after a 2-point calibration (use manual temperature compensation).
Memory Failed Calib. Lost Memory Reset ! You MUST Re-Cal.	User calibration settings have been lost or corrupted.	Re-calibrate the instrument. A full 2-point calibration will be required for pH (see section 3.1) and a 1 point calibration for temperature (see section 5.1).
Meter displays the word OFF , and switches off.	Battery is below 6.00 volts.	Replace the battery.
Meter will not turn on.	Battery is exhausted.	Replace the battery.
Flashing  symbol.	Battery is below 7.50 volts.	Replace the battery. Note that the unit will switch itself off when the battery falls below 6.00 volts.

9.2 pH and mV Troubleshooting

Symptom	Possible Causes	Remedy
Unit fails to calibrate, even with new probe.	Calibration settings outside of allowable limits due to previous failed calibration.	Initialise the unit. See section 8, Initialising the MC-80.
1 Point calibration fails (Asymmetry is greater than +/-1.00 pH).	<ol style="list-style-type: none"> Reference junction blocked. Reference electrolyte contaminated. 	<p>Clean reference junction, as per instructions supplied with the electrode.</p> <p>Flush with distilled water and replace electrolyte.</p>
2 Point calibration fails (Slope is less than 85.0%).	<ol style="list-style-type: none"> Incorrect primary buffer. Glass bulb not clean. Electrode is aged. Connector is damp. Buffers are inaccurate. 	<p>Ensure that you are using the buffers which the MC-80 has been set to automatically recognise (See section 7).</p> <p>Clean glass bulb as per instructions supplied with the electrode.</p> <p>Attempt rejuvenation, as per instructions supplied with the electrode. If not successful, replace electrode.</p> <p>Dry in a warm place.</p> <p>Replace buffers.</p>
Unstable readings.	<ol style="list-style-type: none"> Reference junction blocked. Glass bulb not clean. Bubble in glass bulb. Faulty connection to meter. Reference junction not immersed. KCl crystals around reference junction, inside the electrolyte chamber. 	<p>Clean reference junction, as per instructions supplied with the electrode.</p> <p>Clean glass bulb as per instructions supplied with the electrode.</p> <p>Flick the electrode to remove bubble.</p> <p>Check connectors. Replace if necessary.</p> <p>Ensure that the bulb AND the reference junction are fully immersed.</p> <p>Rinse electrolyte chamber with warm distilled water until dissolved. Replace electrolyte.</p>

Continued next page...

pH and mV Troubleshooting, continued...

Inaccurate readings, even when calibration is successful.	Reference junction blocked.	Clean reference junction, as per instructions supplied with the electrode.
Displays 7.00 for all solutions.	Electrical short in connector.	1. Check connector. Replace if necessary. 2. Replace electrode.
Displays 4-5 pH for all solutions.	Glass bulb or internal stem cracked.	Replace electrode.

9.3 Temperature Troubleshooting

Symptom	Possible Causes	Remedy
Displays "Man" when temperature probe is plugged in.	1. Incorrect temperature probe. 2. Faulty temperature probe.	Fit new temperature probe, part number 121265.
Temperature inaccurate and cannot be calibrated.	1. Faulty connector. 2. Faulty temperature probe.	Check the connector and replace if necessary. Fit new temperature probe, part number 121265.

10. Warranty

TPS Pty. Ltd. guarantees all instruments and electrodes to be free from defects in material and workmanship when subjected to normal use and service. This guarantee is expressly limited to the servicing and/or adjustment of an instrument returned to the Factory, or Authorised Service Station, freight prepaid, within twelve (12) months from the date of delivery, and to the repairing, replacing, or adjusting of parts which upon inspection are found to be defective. Warranty period on electrodes is three (3) months.

There are no express or implied warranties which extend beyond the face hereof, and TPS Pty. Ltd. is not liable for any incidental or consequential damages arising from the use or misuse of this equipment, or from interpretation of information derived from the equipment.

Shipping damage is not covered by this warranty.

PLEASE NOTE:

A guarantee card is packed with the instrument or electrode. This card must be completed at the time of purchase and the registration section returned to TPS Pty. Ltd. within 7 days. No claims will be recognised without the original guarantee card or other proof of purchase. This warranty becomes invalid if modifications or repairs are attempted by unauthorised persons, or the serial number is missing.

PROCEDURE FOR SERVICE

If you feel that this equipment is in need of repair, please re-read the manual. Sometimes, instruments are received for "repair" in perfect working order. This can occur where batteries simply require replacement or re-charging, or where the electrode simply requires cleaning or replacement.

TPS Pty. Ltd. has a fine reputation for prompt and efficient service. In just a few days, our factory service engineers and technicians will examine and repair your equipment to your full satisfaction.

To obtain this service, please follow this procedure:

Return the instrument AND ALL SENSORS to TPS freight pre-paid and insured in its original packing or suitable equivalent. INSIST on a proof of delivery receipt from the carrier for your protection in the case of shipping claims for transit loss or damage. It is your responsibility as the sender to ensure that TPS receives the unit.

Please check that the following is enclosed with your equipment:

- **Your Name and daytime phone number.**
- **Your company name, ORDER number, and return street address.**
- **A description of the fault. (Please be SPECIFIC.)**
(Note: "Please Repair" does NOT describe a fault.)
- **either \$13.50 for return freight for units under warranty,**
or \$24 to cover inspection costs and return freight.

(These amounts are not applicable to full-account customers.)

Your equipment will be repaired and returned to you by air express where possible.

For out-of-warranty units, a repair cost will be calculated from parts and labor costs. If payment is not received for the additional charges within 30 days, or if you decline to have the equipment repaired, the complete unit will be returned to you freight paid, not repaired. For full-account customers, the repair charges will be debited to your account.

- **Always describe the fault in writing.**
- **Always return the sensors with the meter.**

11. Appendices

11.1 pH Electrode Fundamentals

A combination pH Electrode is two electrodes in one. The sensing membrane is the round or spear shaped bulb at the tip of the electrode. This produces a voltage that changes with the pH of the Solution. This voltage is measured with respect to the second part of the electrode, the reference section. The reference section makes contact with the sample solution using a salt bridge, which is referred to as the reference junction. A saturated solution of KCl is used to make contact with the sample. It is vital that the KCl solution has an adequate flow rate in order to obtain stable, accurate pH measurements.

11.1.1 Asymmetry of a pH Electrode

An “ideal” pH electrode produces 0 mV output at 7.00 pH. In practise, pH electrodes, generally produce 0 mV output at slightly above or below 7.00 pH. The amount of variance from 7.00 pH is called the asymmetry. Figure 11-1 illustrates how asymmetry is expressed.

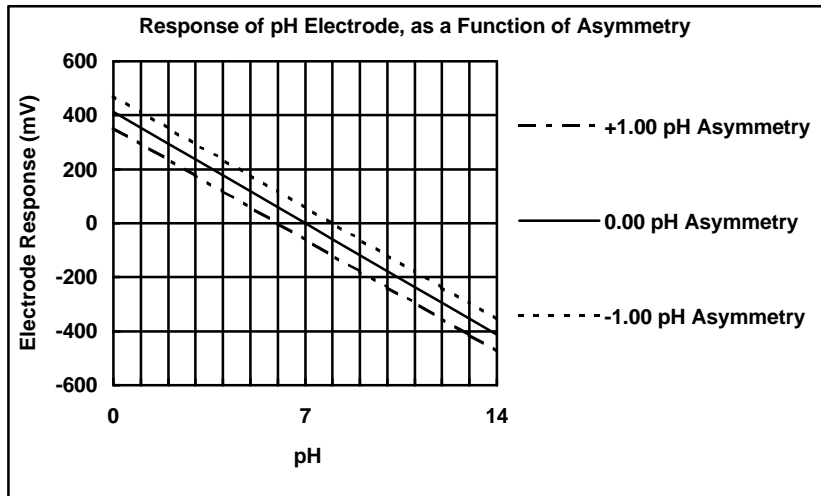

Figure 11-1

11.1.2 The Slope of a pH Electrode

As mentioned above, a pH electrode produces 0 mV output at around 7.00 pH. As the pH goes up, an “ideal” pH electrode produces -59mV/pH unit at 25 °C. As the pH goes down, an ideal pH electrode produces +59mV/pH unit. In practice, pH electrodes usually produce slightly less than this. The output of a pH electrode is expressed as a percentage of an ideal electrode. For example, an ideal electrode that produces 59mV/pH unit has “100% Slope”. An electrode that produces 50.15mV/pH unit has “85% Slope” (see Figure 11-2).

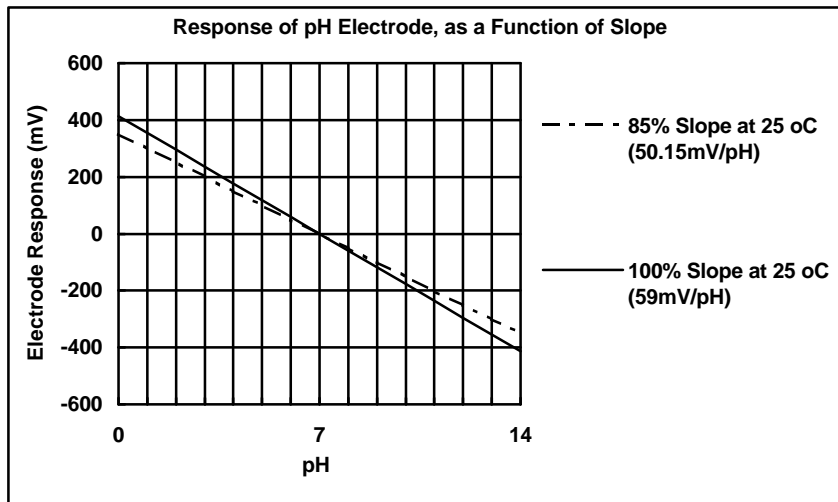

Figure 11-2

11.1.3 Temperature Compensation

The slope of a pH electrode (section 11.1.2) is affected by temperature. This effect is compensated for either by using an Automatic Temperature Compensation (ATC) probe or by entering the sample temperature manually. Figure 11-3 shows the slope of a pH electrode at various temperatures.

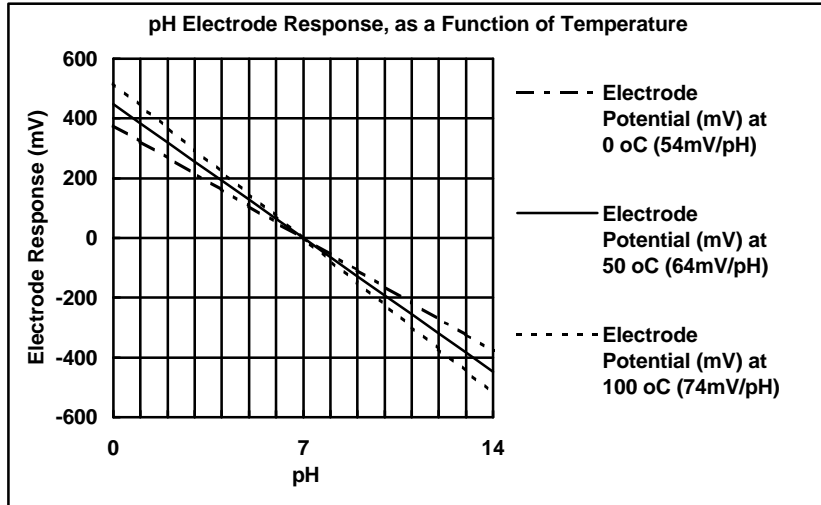

Figure 11-3

11.2 Checking the reference junction of a pH electrode.

If pH readings are inaccurate or unstable, the reference junction of the electrode may be blocked. The following test can be performed to determine if the reference junction of a pH electrode is making adequate contact with the sample solution.

1. Calibrate the **MC-80**, as per section 3.1.
2. Dilute 1 part of pH6.88 buffer with 9 parts of distilled water.
3. Measure the pH of the diluted buffer. The result should be 7.06 +/-0.02 pH.
4. If the value obtained is outside of these limits, then clean the reference junction, as per the instructions supplied with the pH electrode.
5. Re-calibrate the **MC-80** and repeat the test.
6. If the value obtained is still outside 7.06 +/-0.02 pH, then the electrode should be replaced.

11.3 Determining if an instrument or electrode is faulty

The following test can be performed to help determine if the **MC-80** or the pH electrode is faulty.

1. Initialise the **MC-80** (see section 8, Initialising the MC-80).
2. Disconnect the pH electrode.
3. Connect the centre pin of the **Sensor** connector with the outside frame of the connector, using a short piece of wire or a paper clip etc.
4. The meter should read approximately 7.00. If you press the **Cal** key, the **MC-80** will calibrate to around 6.88 pH, depending upon the temperature readout.
5. If the **MC-80** is operating correctly, the reading should be totally stable with the wire firmly in place. If not, the meter requires servicing.
6. Now carefully disconnect the wire from the centre pin only (make sure the other end of the wire remains connected to the outside frame of the connector).
7. The reading should steadily drift away from 7.00 (either up or down) at a rate of approximately 1 pH or less every 3 seconds. If the drift rate is faster than this, then input circuitry of the **MC-80** is faulty and requires servicing.

11.4 Instrument software version number.

If you need to phone or fax TPS for any further technical assistance, the version number of your **MC-80** firmware may be of benefit to us. Please obtain the version number as follows, before phoning or faxing:

1. Switch the **MC-80** on by pressing the **ON/OFF** key.
2. While the model is being displayed, press the **Mode** key.
3. The unit will now display the model and version number,

eg: **TPS MC80**
Ver 2.1