

Congratulations !

The **90-FLMV** is complete water quality logger in a single portable unit. It combines Dissolved Oxygen, Conductivity, TDS, Salinity, pH, ORP and Temperature.

Despite its impressive list of features, the **90-FLMV** is a breeze to operate. This manual has been designed to help you get started, and also contains some handy application tips. If at any stage you require assistance, please contact either your local TPS representative or the TPS factory in Brisbane.

The manual is divided into the following sections:

1. Table of Contents

Each major section of the handbook is clearly listed. Sub-sections have also been included to enable you to find the information you need at a glance.

2. Introduction

The introduction has a diagram and explanation of the display and controls of the **90-FLMV**. It also contains a full listing of all of the items that you should have received with unit. Please take the time to read this section, as it explains some of items that are mentioned in subsequent sections.

3. Main Section

The main section of the handbook provides complete details of the **90-FLMV**, including operating modes, calibration, troubleshooting, specifications, and warranty terms.

4. Appendices

Appendices containing background information and application notes are provided at the back of this manual.

TPS Pty Ltd

ABN 30 009 773 371

Unit 6 / 253 Leitchs Road
Brendale, QLD,
Australia, 4500

Phone : (07) 32 058 027

International : 61 7 32 058 027

Fax : (07) 3808 4871

International : 61 7 3808 4871

Email : tps@tps.com.au

Web : www.tps.com.au

90-FLMV
Dissolved Oxygen,
Conductivity, TDS, Salinity,
pH, ORP, Temperature
Logger

Date : 31-Jan-2012

Version : 10.0

Contents

1

1. Introduction	4
1.1 90-FLMV Display and Controls	4
1.2 90-FLMV Rear Panel Connectors.....	4
1.3 Menu and Function Keys	5
1.4 One-touch Keys.....	5
1.5 Numeric Keys	5
1.6 Delete Key.....	5
1.7 ON and OFF Keys.....	5
1.8 80 Character Display	5
1.9 Unpacking Information	6
1.10 Specifications	8
2. 90-FLMV Menu Structure.....	10
3. Dissolved Oxygen Mode	11
3.1 Selecting Dissolved Oxygen Mode	11
3.2 Dissolved Oxygen Calibration	11
3.3 Dissolved Oxygen Calibration Notes.....	13
3.4 Dissolved Oxygen Calibration Messages.....	13
3.5 Dissolved Oxygen Stirrer.....	14
4. Conductivity Mode.....	15
4.1 Selecting Conductivity Mode.....	15
4.2 Setting the Conductivity calibration standard	15
4.3 Setting the Conductivity sensor k factor	15
4.4 Conductivity Calibration.....	16
4.5 Conductivity Calibration Notes.....	17
4.6 Conductivity Calibration Messages	17
5. TDS Mode.....	18
5.1 Selecting TDS Mode	18
5.2 Setting the Conductivity sensor k factor	18
6. Salinity Mode	19
6.1 Selecting Salinity Mode	19
6.2 Setting the Conductivity sensor k factor	19
7. pH Mode	20
7.1 Selecting the pH Buffer Set.....	20
7.2 pH Calibration.....	21
7.3 pH Calibration Notes.....	22
7.4 pH Calibration Messages	23
8. ORP Mode	24
8.1 ORP Measurements.....	24
9. Temperature Mode	25
9.1 Temperature Calibration	25
9.2 Temperature Calibration Notes	26
9.3 Calibration Messages	26
9.4 Manual Temperature Setting.....	26
10. Good Laboratory Practices (GLP).....	27
10.1 To recall GLP information on the display.....	27
10.2 Failed Calibration.....	28
10.3 Printing GLP Information to the RS232 Port.....	28
10.4 Instrument Serial Number	29
10.5 Additional GLP Features.....	29
11. Data logging	30

		3
11.1	Setting the A & B Data Input Function.....	30
11.2	Manually Recording Readings into the Logger	30
11.3	Automatic Data logging	33
11.4	Recalling Readings from the Logger	36
11.5	Erasing Records from the Logger	37
11.6	Printing Records from the Logger to the RS232 Port	37
12.	RS232 Port.....	38
12.1	Setting the Baud Rate.....	38
12.2	Sending Readings to the RS232 Port	38
12.3	RS232 Configuration	38
12.4	Communication and Statistical Software	38
12.5	Commands	38
12.6	Data Format.....	40
12.7	GLP Data Format	41
12.8	Importing Data into Microsoft Excel	42
13.	Setting the Clock	44
14.	Initialising the 90-FLMV	45
15.	Instrument firmware version number	45
16.	Battery Saver Function	46
17.	Moisture Protection.....	47
17.1	Silica Gel Pack.....	47
18.	Troubleshooting	48
18.1	General Errors.....	48
18.2	Dissolved Oxygen Troubleshooting.....	49
18.3	Conductivity/TDS/Salinity Troubleshooting	50
18.4	pH and ORP Troubleshooting.....	51
18.5	Temperature Troubleshooting.....	52
19.	Appendices	53
19.1	Dissolved Oxygen	53
19.2	Conductivity/TDS/Salinity.....	56
19.3	pH.....	58
20.	Warranty	60

1. Introduction

1.1 90-FLMV Display and Controls

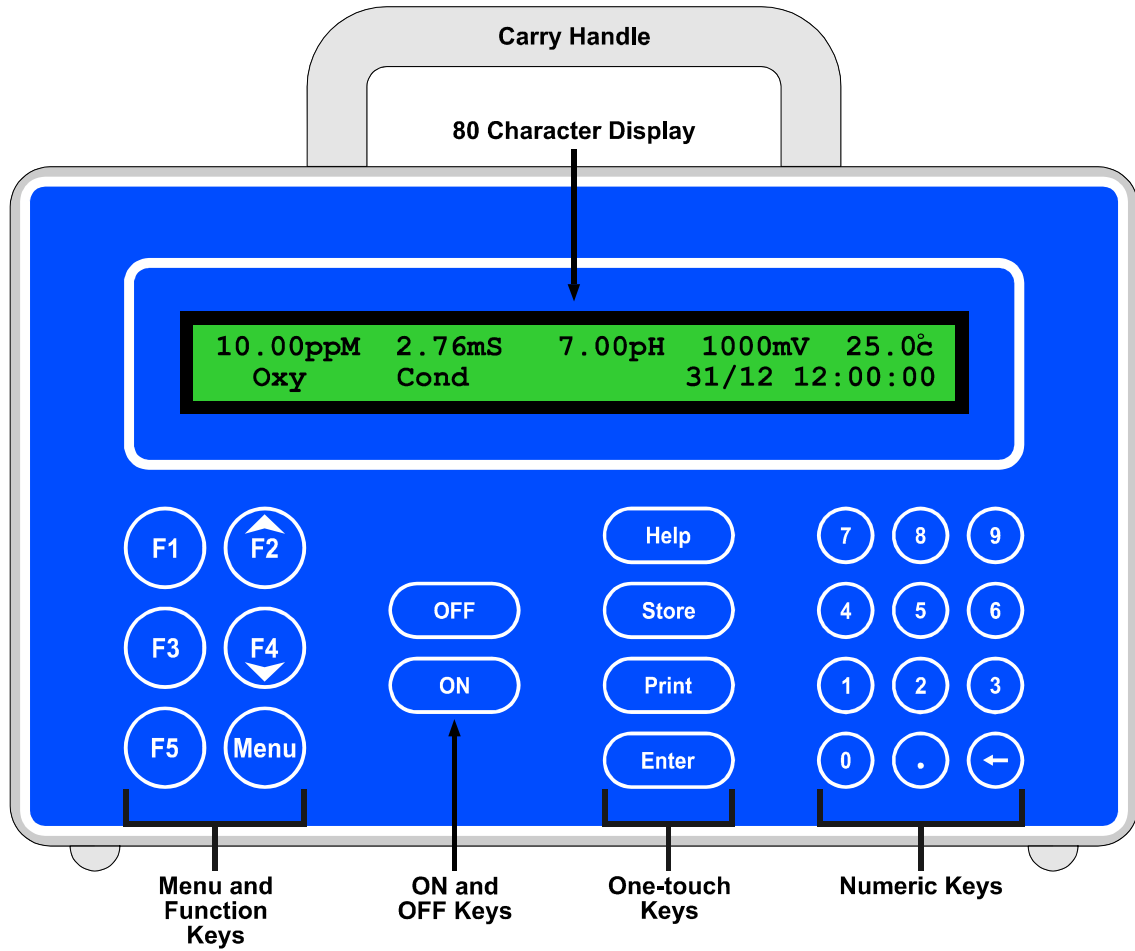

1.2 90-FLMV Rear Panel Connectors

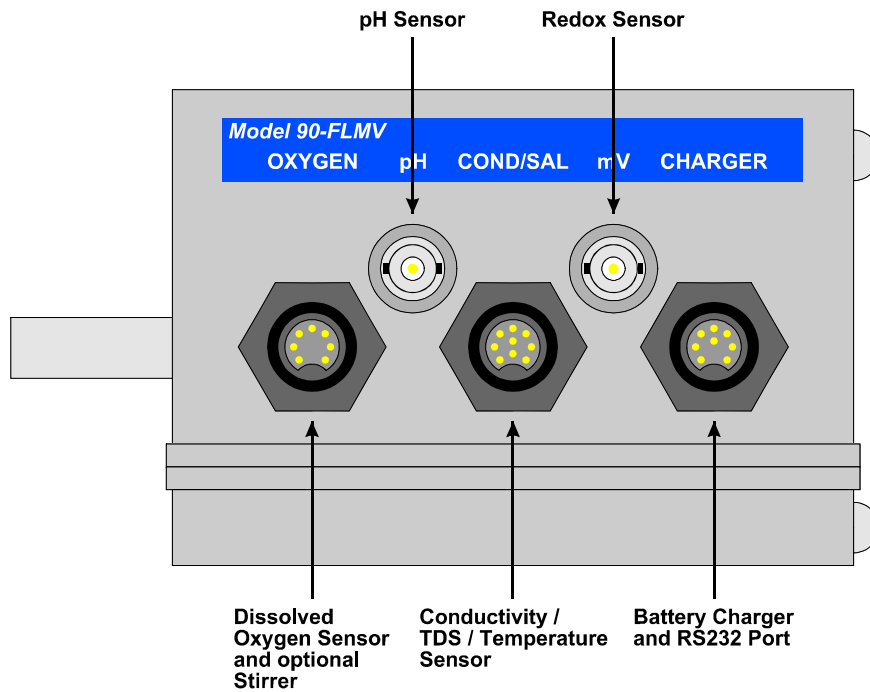

1.3 Menu and Function Keys

Press the **F1** to **F5** function keys to select desired options within the menu system.

Additionally, these keys perform the following function directly in normal measurement mode...

- F2** : Press to start and stop the optional Dissolved Oxygen stirrer. See section 3.5.
- F4** : Press to start automatic data logging in the Sampling Period and Duration mode. See section 11.3.2.

1.4 One-touch Keys

- Help** : Press to obtain context-sensitive help messages. This function is disabled within menus.
- Store** : Press to record readings into the Logger. See section 11.
- Print** : Press to transmit current reading plus date and time to the RS232 port. See section 12.2.
- Enter** : Press the **Enter** key to accept default values or those entered on the Numeric Keypad.

1.5 Numeric Keys

Used to enter values during set-up and calibration. A negative sign and decimal point are provided.

1.6 Delete Key

Press the **←** key to make corrections to values entered on the Numeric Keypad.

1.7 ON and OFF Keys

Press the relevant key to switch the **90-FLMV** on and off as required.

1.8 80 Character Display

80 character alphanumeric display with user-friendly menu and context-sensitive help system. Shows Dissolved Oxygen, Conductivity/TDS/Salinity, pH, ORP, Temperature, Date and Time simultaneously.

1.9 Unpacking Information

Before using your new **90-FLMV**, please check that the following accessories have been included:

	Part No
5 metre bundle 130018/5:	
90-FLMV including 5m cables & sensors.....	130018/5
5 metre Option Includes	
Submersible pH, sensor, 5m cable.....	111224
ORP, Submersible, 5m.....	111259
k=1 Conductivity/TDS/Salinity Temperature Sensor, 5m.....	122196
YSI 5739 Dissolved Oxygen Sensor (no cable).....	123204
5m cable for sensor.....	123219
pH7.00 Buffer, 200mL.....	121387
pH4.01 Buffer, 200mL.....	121381
2.76mS/cm Conductivity Standard, 200mL.....	122306
ORP Standard, 100mL each of Part A and B.....	121309
Battery Charger.....	130009
 Same Price Interchange Option:	
k=10 Conductivity/TDS/Salinity Temperature Sensor, 5m.....	122218
k=0.1 Conductivity/TDS/Salinity Temperature Sensor, 5m.....	122197
 Options and Accessories	
Sensor Upgrade: difficult samples such as meat, dairy, slurries...	
pH , Intermediate Junc, 5m.....	121200/5
ORP , Intermediate Junc, 5m.....	121260/5
 Dissolved Oxygen Field Stirrer:	
YSI 5739 Dissolved Oxygen Sensor Stirrer.....	123306
 Dissolved Oxygen Sensor Maintenance:	
<i>YSI5739 Field Sensor & Non Stirring BOD Sensor</i>	
Membrane & filling solution kit.....	123300
Filling Solution only, 45mL.....	123303
Zero calibration Sodium Sulphite.....	123302
Rejuvenation kit.....	123037
Diaphragm replacement kit.....	123304
<i>(Above for YSI5739 Field Sensor Only)</i>	
 Temperature Sensor:	
Temperature Sensor, 5m cable.....	124210
 Sensor Holders:	
Sensor holder for 90FL & 90FL-MV, 5m cable.....	121343
 Computer Interface:	
RS232 serial port cable to connect to computer.	130015
Serial to USB adaptor cable (used with 130015).....	130087
WinTPS Software for Windows.....	130086
 Power options:	
12V Solar charging panel.....	130012

12V Car cigarette lighter lead.....	130013
Clip lead for external 12V battery.....	130024
Carry case:	
Waterproof carry case.....	130058

1.10 Specifications

	Ranges	Resolution	Accuracy
Oxygen	0 to 30.00 ppM 0 to 300.0 % Sat 0 to 60.0 % Gas	0.01 ppM 0.1 % Sat 0.1 % Gas	±0.02 ppM ±0.2 % Saturation ±0.1 % Gaseous
Conductivity	k=0.1 cell 0 to 2.000 μS/cm 0 to 20.00 μS/cm 0 to 200.0 μS/cm 0 to 2000 μS/cm k=1 cell 0 to 20.00 μS/cm 0 to 200.0 μS/cm 0 to 2000 μS/cm 0 to 20.00 mS/cm k=10 cell 0 to 200.0 μS/cm 0 to 2000 μS/cm 0 to 20.00 mS/cm 0 to 200.0 mS/cm	0.001 μS/cm 0.01 μS/cm 0.1 μS/cm 1 μS/cm 0.01 μS/cm 0.1 μS/cm 1 μS/cm 0.01 mS/cm 0.1 μS/cm 1 μS/cm 0.01 mS/cm 0.1 mS/cm	±0.5% of full scale of selected range at 25 °C
TDS	k=0.1 cell 0 to 1.000 ppM 0 to 10.00 ppM 0 to 100.0 ppM 0 to 1000 ppM k=1 cell 0 to 10.00 ppM 0 to 100.0 ppM 0 to 1000 ppM 0 to 10.00 ppK k=10 cell 0 to 100.0 ppM 0 to 1000 ppM 0 to 10.00 ppK 0 to 100.0 ppK	0.001 ppM 0.01 ppM 1 ppM 0.01 ppK 0.01 ppM 0.1 ppM 1 ppM 0.01 ppK 0.1 ppM 1 ppM 0.01 ppK 0.1 ppK	±0.5% of full scale of selected range at 25 °C
Salinity	k=0.1 cell 0 to 0.10 % 0 to 1.0 PSU k=1 cell 0 to 1.19 % 0 to 11.9 PSU k=10 cell 0 to 8.00 % 0 to 80.0 PSU	0.01 % 0.1 PSU	±0.5% of full scale of selected range at 25 °C
pH	0 to 14.00 pH	0.01 pH	±0.01 pH
ORP	0 to ±2000 mV	1 mV	±1 mV
Temperature	-10.0 to 110.0 °C (Cond sensor limit 60 °C)	0.1 °C	±0.2 °C

Additional Oxygen Specifications

Sensor TypeClark type polarographic sensor with in-built ATC.

Salinity Correction for ppM0 to 50.0 ppK, automatic using Conductivity reading.

Temperature Compensation.....Automatic for membrane permeability.

Automatic for Dissolved Oxygen solubility in ppM mode.

CalibrationAutomatic zero and span calibration.

Sensor Span Range65 to 200 %

Additional Conductivity/TDS/Salinity Specifications

Temperature Compensation.....Automatic, -5 to 70.0 °C
 Conductivity Sensor Span Range75 to 133 %
 Auto Standard RecognitionConductivity: 20uS/cm to 200mS/cm user selected
 TDS Factor0.40 to 1.00, user selected

Additional pH Specifications

Temperature Compensation.....Automatic, -5 to 100.0 °C
 pH Input Impedance.....>3 x 10¹² Ω
 pH Asymmetry Range.....-1.00 to 1.00 pH
 pH Slope Range85.0 to 105.0%
 Auto pH Buffer RecognitionpH4.01, pH6.86, pH7.00, pH9.18, pH10.01
 Any other can be entered during calibration.

Additional mV Specifications

ORP Input Impedance.....>3 x 10¹² Ω

Additional Temperature Specifications

Temperature Sensor Offset Range.....-10.0°C to +10.0°C

1.10.1 General Specifications

Memory 7230 readings including date and time with A&B function disabled.
 5950 readings including date and time with A&B function enabled.

Automatic Logging..... **Rate per Day**
 1 to 288 readings per day.

Sampling Period and Duration
 One reading every 1 to 300 seconds for a duration of 1 to 720 minutes or continuous.

RS232 Port 300, 9600 & 19200 baud.
 8 bits, no parity, 1 stop bit, XON/XOFF Protocol.

Clock..... Calendar clock displays date, month, hours, minutes & seconds. Year is Y2K compliant and is attached to all stored data.

Good Laboratory Practices..... Date, time and results of last calibration for all parameters are stored. This information can be recalled or sent to the RS232 port at any time.

Power 7.2V, 1300mAH NiCad battery built in.
 Battery charger for country of destination is included.
 Solar panel and external battery clip lead optionally available.

Battery Saver..... Auto switch-off after 5 minutes or 1 hour. Battery saver can be switched off to allow continuous use.

Dimensions 230 x 140 x 100 mm

Mass..... Instrument only : Approx. 1.5 kg
 Full Kit : Approx. 5.0 kg

Environment..... Temperature : 0 to 45 °C
 Humidity : 0 to 90 % R.H.

2. 90-FLMV Menu Structure

A detailed breakdown of the menu system of the **90-FLMV** is shown below. This diagram provides a quick reference for the menu functions available for the **90-FLMV**.

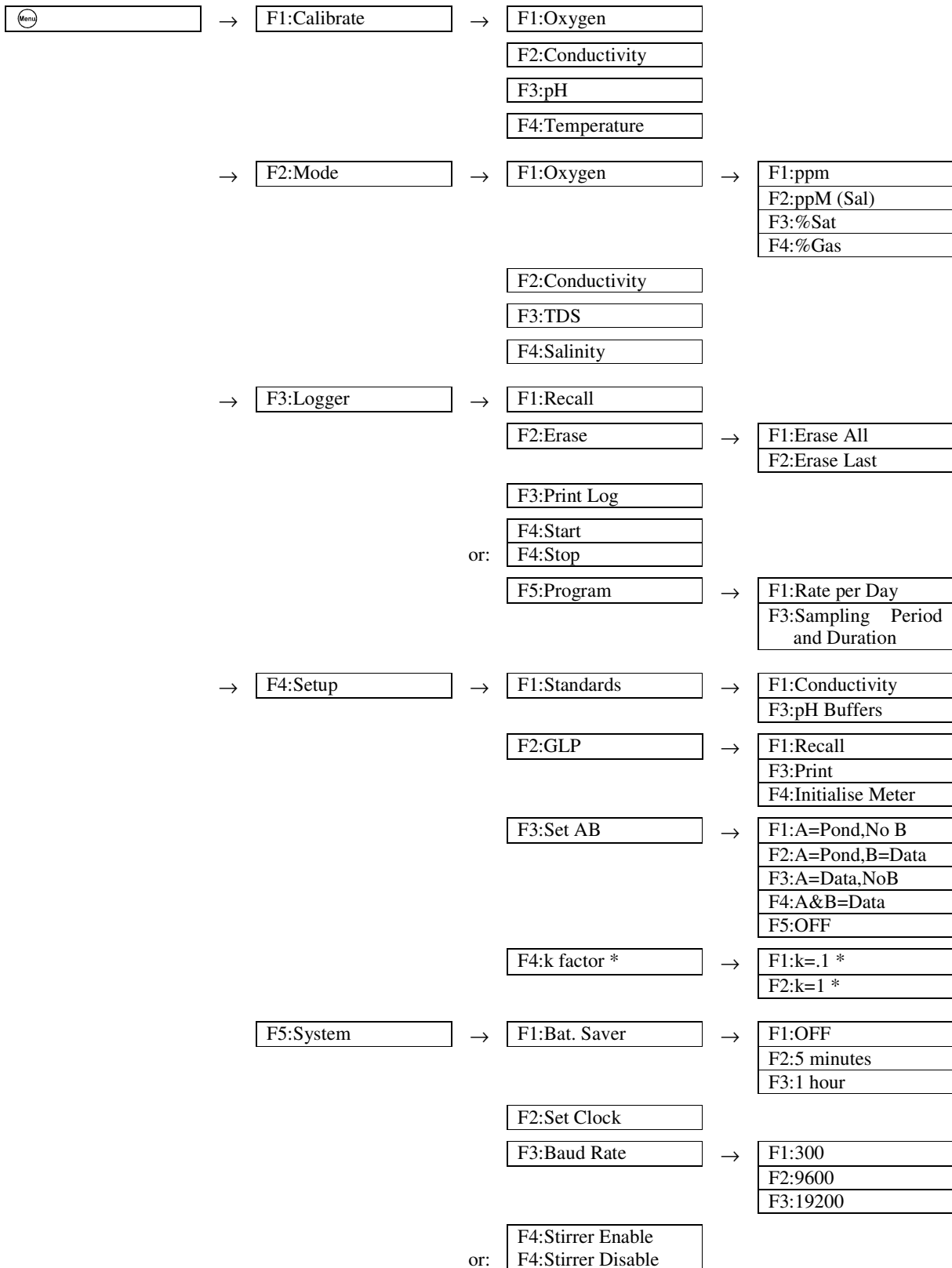

* This function not available when a TPS k=10 sensor is connected.

3. Dissolved Oxygen Mode

3.1 Selecting Dissolved Oxygen Mode

1. Select Dissolved Mode (Menu) → **F2:Mode** → **F1:Oxygen**).
2. The Dissolved Oxygen readout units selection screen is now displayed...

MODE	F1:ppm	F2:ppM (Sal)
	>F3:% Sat	F4:% Gas

The arrow indicates the current selection.

Press (F1) to select Dissolved Oxygen readout in ppm units. This selection will not apply Salinity correction to the displayed readings.

Press (F2) to select Dissolved Oxygen readout in Salinity-corrected ppM units. This selection will use the Conductivity reading for automatic salinity correction.

Press (F3) to select Dissolved Oxygen readout in % Saturation units.

Press (F4) to select Dissolved Oxygen readout in % Gaseous units.

Press (Menu) to quit without changing the current setting.

3.2 Dissolved Oxygen Calibration

1. Plug the Dissolved Oxygen sensor into the **Oxygen** socket.
2. Switch the meter on.
3. Select the Dissolved Oxygen readout mode to be used, as detailed in section 3.1.
4. Ensure that the Temperature readout has been calibrated (see section 9.1) or manually set (see section 9.4).
5. Rinse the Dissolved Oxygen sensor in distilled water and blot dry.

3.2.1 Zero Calibration (all Oxygen modes)

1. Place the Dissolved Oxygen sensor into an oxygen-free solution. This solution may be prepared by dissolving 2g of Sodium Sulphite in 100mL of distilled water. A 50g bottle of Sodium Sulphite powder (part number 123302) is supplied with a new Dissolved Oxygen sensor or Membrane Kit for this purpose.
2. Allow the reading to stabilise at or near zero. This may take 2-3 minutes.
3. Select Oxygen Calibration. (Menu) → **F1:Calibrate** → **F1:Oxygen**)

When the reading is below approximately 25 % Saturation, 2 ppM or 5% Gaseous, the **90-FLMV** will display the ZERO calibration screen...

1*0%Sat	25.0°C
Oxygen ZERO Calibration, Press Enter	

4. Press (Enter) to calibrate.

A "*" will not be removed from the display after a Zero Calibration.

5. Remove the sensor from the Zero solution, rinse well in distilled water and blot dry.

The **90-FLMV** will now prompt you to perform an AIR calibration.

3.2.2 Span Calibration in Air (all Oxygen modes)

1. Hang the Dissolved Oxygen sensor in air. The tip of the Dissolved Oxygen sensor should be pointing downwards.

Allow the reading to stabilise. After a zero calibration, this may take up to 5 minutes.

2. Select Oxygen Calibration. (Menu) → **F1:Calibrate** → **F1:Oxygen**)

When the reading is above approximately 25% Saturation, 2 ppM or 5% Gaseous, the **90-FLMV** will display the AIR calibration screen...

101.0%Sat	25.0°C
Oxygen AIR	Calibration, Press Enter

Press (Enter) to calibrate.

A “*” in the display will be replaced by a decimal point after a successful air calibration.

3. The **90-FLMV** is now calibrated and is ready for Dissolved Oxygen measurements. Rinse the Dissolved Oxygen sensor in distilled water and blot dry before placing it into unknown samples.

3.2.3 Span Calibration in Solution (Salinity-corrected ppM Mode only)

This span calibration provides an alternative to calibrating the Dissolved Oxygen sensor in air. It is only available when the **90-FLMV** is in Salinity-corrected ppM mode. Please note that the normal AIR calibration (section 3.2.2) is still available for Salinity-corrected ppM mode.

1. Measure the Dissolved Oxygen content of the solution to be used for calibration. This is generally done with a Winkler titration. The **90-FLMV** span calibration should be performed immediately the Dissolved Oxygen content of the solution is known, as the value may not be stable.
2. Place the Dissolved Oxygen and Conductivity sensors into the calibration solution. Ensure that the Conductivity sensor is calibrated and is correctly immersed (see section 4.4).

The solution must be stirred at a moderate rate.

Allow the reading to stabilise. After a zero calibration, this may take up to 5 minutes.

3. Select Oxygen Calibration. (Menu) → **F1:Calibrate** → **F1:Oxygen**)

When the reading is above approximately 2 ppM, the **90-FLMV** will display the AIR/SPAN calibration screen. Note the cursor underlining the “A” in “Air”.

9.10ppM	25.0°C
Oxygen <u>A</u> IR/SPAN	Calibration, Press Enter

Use the numeric keypad to enter the Dissolved Oxygen value of the solution. The words “AIR/SPAN” are deleted and the value being entered is displayed. The Conductivity or TDS or Salinity reading also appears as soon as the first numeric key is pressed.

Press the (←) to correct any errors.

Ensure that the Dissolved Oxygen, Conductivity or TDS or Salinity, and Temperature readings are fully stable.

Press (Enter) to calibrate.

A “*” in the display will be replaced by a decimal point after a successful air calibration.

4. The **90-FLMV** is now calibrated and is ready for Dissolved Oxygen measurements. Rinse the Dissolved Oxygen sensor in distilled water and blot dry before placing it into unknown samples.

3.3 Dissolved Oxygen Calibration Notes

1. The relationship of % Saturation and ppM depends on a number of variables, so *always calibrate in the mode required*. Do not try to infer Oxygen content from one mode to another.
2. A zero calibration should be performed at least monthly. In applications where there is a low level of dissolved oxygen, a zero calibration may have to be done weekly.
3. An air calibration should be performed at least weekly. Of course, more frequent calibration will result in greater confidence in results.
4. All calibration information is retained in memory when the **90-FLMV** is switched off. This information can be recalled or printed later using the GLP function (see section 10).

3.4 Dissolved Oxygen Calibration Messages

1. If a Zero calibration has been successfully performed, the **90-FLMV** will display the following message and the Zero value of the sensor...

```

0.0%Sat                25.0°C
Calibration OK,      Zero=0.5%
  
```

2. If a Zero calibration has failed, the **90-FLMV** will display the following message and the failed Zero value of the sensor. The unit will return to normal display mode with a “ * ” in place of the decimal point in the Dissolved Oxygen reading.

```

15.0%Sat                25.0°C
Calibration Failed,  Zero=15.0%
  
```

3. If an Air/Span calibration has been successfully performed, the **90-FLMV** will display the following message and the Span value of the sensor...

```

100.0%Sat              25.0°C
Calibration OK,      Span=100.0%
  
```

4. If an Air/Span calibration has failed, the **90-FLMV** will display the following message and the failed Span value of the sensor. The decimal point will be replaced by a “ * ” when the unit returns to normal display mode.

```

205.0%Sat              25.0°C
Calibration Failed,  Span=205.0%
  
```

5. The allowable Span range for a Dissolved Oxygen sensor is 65.0 to 200.0 %. If calibration fails due to the Span value being outside these limits, then please consult the Troubleshooting guide (section 18.2) for possible remedies.

3.5 Dissolved Oxygen Stirrer

The 90-FLMV is equipped with a 4.5V DC output to power a stirrer for the Dissolved Oxygen sensor. This power output is suitable for the TPS submersible DO₂ stirrer (part number 123306).

3.5.1 Enabling and Disabling the Dissolved Oxygen stirrer output

1. Select the System menu (Menu → **F5: System**).
2. Select **F4: Stirrer Enable** or **F4: Stirrer Disable** from the menu as required.

3.5.2 Connecting the Dissolved Oxygen stirrer

To connect the Dissolved Oxygen stirrer...

1. Plug the Dissolved Oxygen stirrer into the **Oxygen** socket on the meter.
2. Plug the Dissolved Oxygen sensor into the in-line socket that is provided on the stirrer cable.

Please refer to the diagram below.

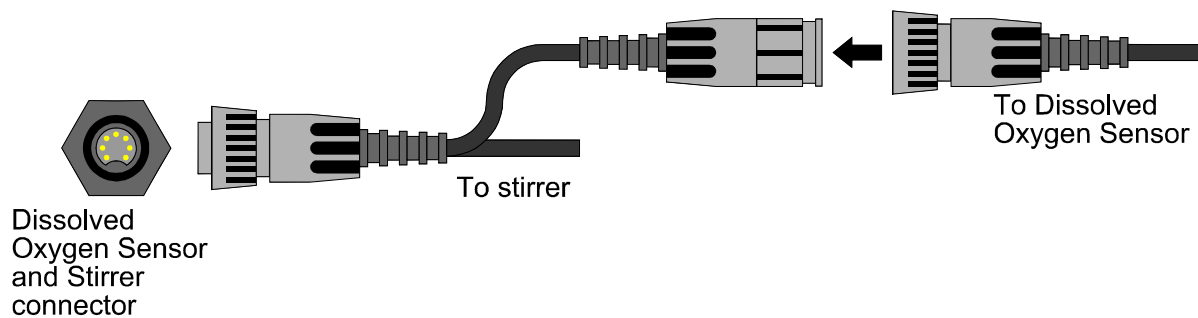

3.5.3 Starting and Stopping the Dissolved Oxygen stirrer

1. Ensure that the Dissolved Oxygen stirrer output has been enabled, as per section 3.5.1.
2. Press **F2** once in normal display mode to start the stirrer. The stirrer will stay on for 40 seconds and then stop. A countdown is provided on the screen.
3. Press **F2** a second time any time during the 40 second period to set the Dissolved Oxygen stirrer to operate continuously.
4. Press **F2** a third time to stop the Dissolved Oxygen stirrer.

The Dissolved Oxygen stirrer starts and stops automatically when the 90-FLMV is in Rate per Day automatic data logging mode. See section 11.3.1.

4. Conductivity Mode

4.1 Selecting Conductivity Mode

1. Select Conductivity Mode (Menu → F2:Mode → F2:Conductivity).
2. The 90-FLMV now proceeds to Conductivity measurement mode. Note that a “ * ” is shown in place of the decimal point until a successful calibration has been performed (see section 4.4).

4.2 Setting the Conductivity calibration standard

The factory default for this item is 2.76mS/cm. If this is satisfactory, go directly to section 4.3.

1. Select the Conductivity Standard entry

(Menu) → F4:Setup → F1:Standards → F1:Conductivity).

The following screen is now displayed...

```
Conductivity Standard:2760 uS
Range 20uS/cm to 2000mS/cm
```

2. Type in the value of the Conductivity standard that is to be used for calibration, including the decimal point. Use the ← key to make any corrections.
3. Press (Enter) to save the value of the standard solution.
Alternatively, press (Menu) to quit without changing the current setting.
4. The 90-FLMV will now ask you to enter the units for the Conductivity standard...

```
Conductivity Standard:2760
Select Units   F1:uS/cm   F2:mS/cm
```

Press (F1) to set the Conductivity Standard as $\mu\text{S/cm}$.

Press (F2) to set the Conductivity Standard as mS/cm .

5. The Conductivity standard is now programmed for use at calibration.

4.3 Setting the Conductivity sensor k factor

The 90-FLMV automatically recognises a k=10 sensor. If a k=10 sensor is being used, go directly to section 4.4.

The 90-FLMV **does not** automatically recognise k=0.1 or k=1 sensors. When a k=0.1 or k=1 sensor is used, the 90-FLMV must be set to the correct k factor before use.

To select a k=0.1 or k=1 sensor...

1. Select k factor entry (Menu) → F4:Setup → F4:k factor).
2. The k factor entry screen is now displayed. The arrow indicates the current selection.

```
Select nominal k factor,
F1:k=.1           >F2:k=1
```

Press (F1) if a k=0.1 sensor is being used.

Press (F2) if a k=1 sensor is being used.

Press (Menu) to quit without changing the current setting.

Notes

1. The manual k factor selection is reset to k=1 during initialisation.
2. The 90-FLMV will always automatically recognise a k=10 sensor, regardless of the manual k factor selection.
3. Calibration settings for k=0.1, k=1 and k=10 sensors are NOT stored separately. The 90-FLMV requires re-calibration when a new k factor sensor is connected.

4.4 Conductivity Calibration

To achieve accurate Conductivity/TDS/Salinity results, the **90-FLMV** requires calibration to a known Conductivity standard. The TDS and Salinity values are derived from the Conductivity reading and do not require a separate calibration. The conductivity of a solution varies with temperature. The **90-FLMV** uses Automatic Temperature Compensation (ATC) referenced to the fixed temperature of 25°C.

Before attempting a Conductivity calibration, ensure that the **90-FLMV** has been set up correctly according to sections 4.1 to 4.3.

1. Plug the Conductivity sensor into the **Cond/Sal** socket.
2. Rinse the Conductivity sensor in distilled water. Shake off as much water as possible. Blot the outside of the sensor dry. **DO NOT BLOT THE SENSOR WIRES.**

Zero Calibration

3. Let the sensor dry in air.
4. Select Conductivity Calibration (Menu) → **F1:Calibrate** → **F2:Conductivity**).
5. The **90-FLMV** will recognise the low conductivity signal and attempt a Zero calibration. For example...

0*01uS	25.0°C
Cond. ZERO	Calibration, Press Enter

6. When the reading has stabilised at or near zero, press (Enter) to calibrate or (Menu) to quit. The “*” will not be removed after a zero calibration.

Standard Calibration

7. Place the Conductivity sensor into a sample of Conductivity standard. Ensure that it is immersed correctly, as per the diagram below.

DO NOT place the sensor directly into the bottle of standard. Discard the used sample of standard after use.

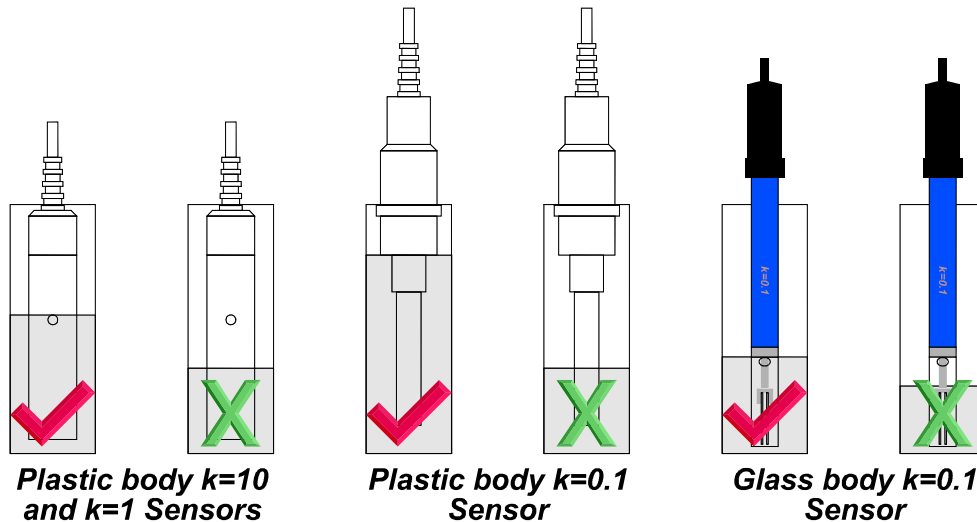

8. Select Conductivity Calibration (Menu) → **F1:Calibrate** → **F2:Conductivity**). The calibration screen will be displayed with the Conductivity standard to be used. For example...

2*86mS	25.0°C
Cond. 2760uS	Calibration, Press Enter

9. When the reading has stabilised, press **Enter** to calibrate. The “ * ” will now be replaced by a decimal point if calibration was successful.
10. The **90-FLMV** is now calibrated for Conductivity. The TDS and Salinity values are derived from the Conductivity reading and do not require a separate calibration.
Ensure that the sensor is immersed at least as deeply as per the diagram in step 7 for all sample measurements.

4.5 Conductivity Calibration Notes

1. A Zero calibration should be performed at least monthly. In low conductivity applications (where a zero error is particularly significant), a zero calibration may have to be done weekly.
2. A Standard calibration should be performed at least weekly. Of course, more frequent calibration will result in greater confidence in results.
3. All calibration information is retained in memory when the **90-FLMV** is switched off. This information can be recalled or printed later using the GLP function (see section 10).
4. The **90-FLMV** displays the value of the standard to which it will attempt to calibrate. Ensure that the standard value displayed corresponds to the standard that you are using. Alter the Standards set-up if necessary (see section 4.2).
5. Calibration settings for k=0.1, k=1 and k=10 sensors are NOT stored separately.
The **90-FLMV** requires re-calibration when a new k factor sensor is connected.

4.6 Conductivity Calibration Messages

1. If a Zero Calibration has been successfully performed, the **90-FLMV** will display the following message...

```

0.00uS                               25.0°C
Calibration OK, Zero=0.01uS

```

2. If a Standard Calibration has been successfully performed, the **90-FLMV** will display the following message and the calculated k factor of the sensor. For example...

```

2.76mS                               25.0°C
Calibration OK, k=0.99

```

3. If a Standard Calibration has failed, the **90-FLMV** will display the following message and the calculated k factor of the sensor. For example...

```

Calibration Failure. Check STD=2760uS/cm
k=3.64, Exceeds Limit

```

Notes

1. The allowable k factor range is +/-25% of nominal. This range is ample to allow for correctly functioning Conductivity sensors. If calibration fails due to the k factor being outside these limits, then please consult the Troubleshooting guide (section 18.3) for possible remedies.

5. TDS Mode

5.1 Selecting TDS Mode

1. Select TDS Mode (Menu) → **F2:Mode** → **F3:TDS**).
2. You will now be asked to enter the TDS factor. Type in the required factor between 0.40 and 1.00 and press (Enter) to save the value or (Menu) to quit.
The TDS factor will be reset to 0.65 when the meter is initialized.

Input TDS Factor: 0.65

3. The **90-FLMV** is now in TDS measurement mode.

5.2 Setting the Conductivity sensor k factor

The **90-FLMV** automatically recognises a k=10 sensor.

The **90-FLMV** **does not** automatically recognise k=0.1 or k=1 sensors. When a k=0.1 or k=1 sensor is used, the **90-FLMV** must be set to the correct k factor before use.

To select a k=0.1 or k=1 sensor...

3. Select k factor entry (Menu) → **F4:Setup** → **F4:k factor**).
4. The k factor entry screen is now displayed. The arrow indicates the current selection.

**Select nominal k factor,
F1:k=.1 >F2:k=1**

Press (F1) if a k=0.1 sensor is being used.

Press (F2) if a k=1 sensor is being used.

Press (Menu) to quit without changing the current setting.

Notes

4. The manual k factor selection is reset to k=1 during initialisation.
5. The **90-FLMV** will always automatically recognise a k=10 sensor, regardless of the manual k factor selection.
6. Calibration settings for k=0.1, k=1 and k=10 sensors are NOT stored separately.

The **90-FLMV** requires re-calibration when a new k factor sensor is connected.

6. Salinity Mode

6.1 Selecting Salinity Mode

1. Select Salinity Mode (Menu) → **F2:Mode** → **F4:Salinity**).
2. You will now be asked to select the Salinity units.
Press (F1) to select “%” as the units.
Press (F2) to select “PSU” as the units..

Salinity Units F1:% F2:PSU

3. The **90-FLMV** is now in Salinity measurement mode.

6.2 Setting the Conductivity sensor k factor

The **90-FLMV** automatically recognises a k=10 sensor.

The **90-FLMV** **does not** automatically recognise k=0.1 or k=1 sensors. When a k=0.1 or k=1 sensor is used, the **90-FLMV** must be set to the correct k factor before use.

To select a k=0.1 or k=1 sensor...

1. Select k factor entry (Menu) → **F4:Setup** → **F4:k factor**).
2. The k factor entry screen is now displayed. The arrow indicates the current selection.

Select nominal k factor,
F1:k=.1 >F2:k=1

Press (F1) if a k=0.1 sensor is being used.

Press (F2) if a k=1 sensor is being used.

Press (Menu) to quit without changing the current setting.

Notes

1. The manual k factor selection is reset to k=1 during initialisation.
2. The **90-FLMV** will always automatically recognise a k=10 sensor, regardless of the manual k factor selection.
3. Calibration settings for k=0.1, k=1 and k=10 sensors are NOT stored separately.
The **90-FLMV** requires re-calibration when a new k factor sensor is connected.

7. pH Mode

7.1 Selecting the pH Buffer Set

The **90-FLMV** can be programmed to automatically recognise any of the following buffer sets during pH calibration. All pH values listed below are at 25 °C.

1. pH4.01, pH7.00, pH9.18
2. pH4.01, pH7.00, pH10.01
3. pH4.01, pH6.86, pH9.18
4. pH4.01, pH6.86, pH10.01.

To select the pH buffer set for automatic recognition...

1. Select the pH Buffer set-up menu.

(Menu) → **F4: Setup** → **F1: Standards** → **F3: pH Buffers**).

2. The primary buffer selection menu is now displayed...

```
Select Primary Buffer
>F1: 7.00pH      F2: 6.86pH
```

The arrow indicates the current selection.

Press (F1) to select pH7.00 as the Primary Buffer.

Press (F2) to select pH6.86 as the Primary Buffer.

Press (Menu) to quit without changing the current setting.

3. The secondary buffers selection menu is now displayed...

```
Select Secondary Buffers
>F1: 4.01/9.18pH      F2: 4.01/10.01pH
```

The arrow indicates the current selection.

Press (F1) to select pH4.01 and pH9.18 as the Secondary Buffers.

Press (F2) to select pH4.01 and pH10.01 as the Secondary Buffers.

Press (Menu) to quit without changing the current setting.

Notes

1. The selected buffer set is kept in memory when the meter is switched off.
2. **pH9.18 and pH10.01 buffers are unstable once the bottles have been opened. Discard immediately after use.**
3. If you wish to use a pH buffer other than one of those listed above, its value can be keyed in during calibration. Make sure that you have pH versus Temperature data for the buffer.

7.2 pH Calibration

1. Plug the pH sensor into the **pH** socket and the Conductivity or Temperature sensor into the **COND/SAL** socket. Switch the meter on.
2. Ensure that temperature has already been calibrated (see section 9.1) or manually set (see section 9.4. NOTE: The decimal point in the Temperature reading is shown by a “ * ”, when the temperature readout is not calibrated).
3. Remove the wetting cap from the pH sensor. Rinse the pH and Conductivity or Temperature sensors in distilled water and blot them dry.
4. Ensure that the primary and secondary buffers to be used have been correctly selected for automatic buffer recognition. See section 7.1.
5. Place both sensors into a small sample of primary buffer (pH7.00 or 6.86), so that the bulb and reference junction are both covered as per the diagram below.

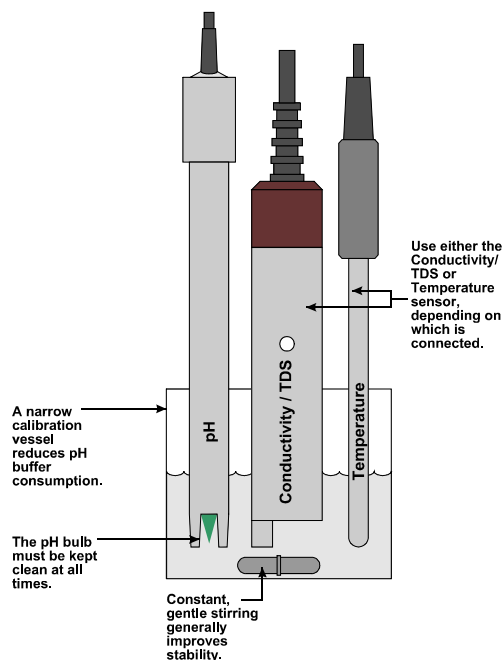

DO NOT place the sensors directly into the buffer bottle.

6. Select pH calibration (Menu) → **F1:Calibrate** → **F3:pH**).

The display should now look something like this...

```

6*95pH      Buffer=7.00      25.0°C
Press ENTER to Calibrate, or Edit Buffer.

```

The current pH reading is shown on the left. Note the “ * ”, indicating that pH is currently not calibrated. Wait for this reading to stabilise before attempting to calibrate the **90-FLMV**.

The buffer that the **90-FLMV** has attempted to recognise is also displayed with the correct value at the current temperature.

Press (Enter) to calibrate to the displayed buffer.

Otherwise, enter an alternative buffer using the Numeric Keypad, and then press (Enter).

The meter is now 1 point calibrated. Note that the “ * ” will not be removed until a full 2 point calibration has been performed.

7. Rinse the pH and Conductivity or Temperature sensors in distilled water and blot them dry.
8. Place both sensors into a small sample of secondary buffer (pH4.01, 9.18 or 10.01), so that the bulb and reference junction are both covered as per the diagram in step 5.

DO NOT place the sensors directly into the buffer bottle.

pH9.18 and pH10.01 buffers are unstable once the bottles have been opened. Discard immediately after use.

9. Select pH calibration ( → **F1:Calibrate** → **F3:pH**).

The display should now look similar to the example shown in step 6. Note that the **90-FLMV** has automatically recognised the second buffer.

Wait for the displayed reading to stabilise before attempting to calibrate the **90-FLMV**.

Press  to calibrate to the displayed buffer.

Otherwise, enter an alternative buffer using the Numeric Keypad, and then press .

10. The **90-FLMV** is now pH calibrated and is ready for use in this mode. Discard the used samples of buffer.

Rinse the pH and Conductivity or Temperature sensors in distilled water and blot them dry before placing them into unknown samples.

7.3 pH Calibration Notes

1. A 1-point calibration should be performed at least weekly. In applications where the sensor junction can become blocked such as dairy products, mining slurries etc, a 1-point calibration may have to be done daily.
2. A 2-point calibration should be performed at least monthly. Of course, more frequent calibration will result in greater confidence in results.
3. All calibration information is retained in memory when the **90-FLMV** is switched off, even when the power supply is removed. This information can be recalled or printed later using the GLP function (see section 10).

7.4 pH Calibration Messages

1. If a 1-point calibration has been successfully performed, the **90-FLMV** will display the following message and the asymmetry of the sensor. Note that the slope value from the last calibration is also shown.

```
Asymmetry Calibration Successful  
+0.10pH Asym      100% Slope
```

2. If a 1-point calibration has failed, the **90-FLMV** will display the following message and the failed asymmetry value of the sensor.

```
Calibrate Failed, 1.2pH Asymmetry  
Repeat Cal. or Initialise Calibration
```

3. If a 2-point calibration has been successfully performed, the **90-FLMV** will display the following message and the asymmetry and slope of the sensor.

```
Slope & Asymmetry Calibration Successful  
+0.10pH Asym      99.0% Slope
```

4. If a 2-point calibration has failed, the **90-FLMV** will display the following message and the failed slope value of the sensor.

```
Calibrate Failed, 80% Slope  
Repeat Cal. or Initialise Calibration
```

5. The **90-FLMV** has an allowable Asymmetry range of -1.00 to $+1.00$ pH. The allowable Slope range is 85.0 to 105.0 %. If calibration fails due to either the Asymmetry or the Slope being outside these limits, then please consult the Troubleshooting guide (section 18.4) for possible remedies.

8. ORP Mode

8.1 ORP Measurements

The millivolt section of the **90-FLMV** is factory calibrated. There is no user-calibration facility for this mode.

Temperature compensation is not applicable in ORP mode.

Simply plug the Redox sensor into the **mV** socket. Ensure that the platinum tip and reference junction are both covered, as per the diagram below.

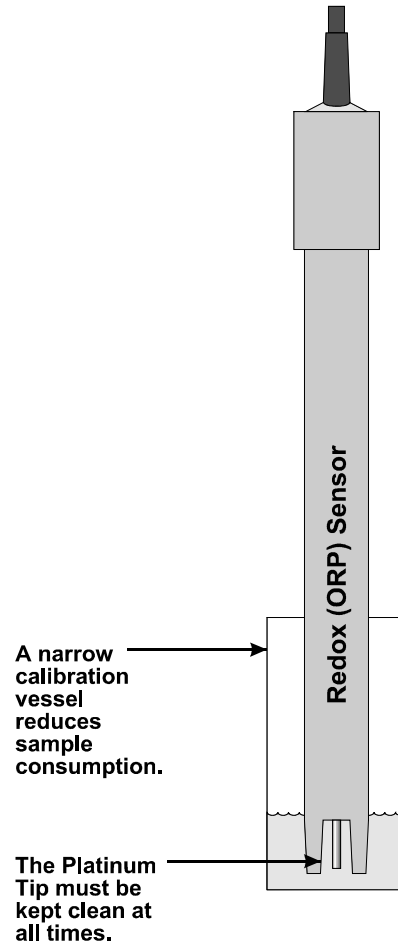

9. Temperature Mode

The temperature readout must be calibrated before attempting pH or ppM Dissolved Oxygen calibration and measurements.

The decimal point is replaced by a “*” if the reading is not calibrated.

The **90-FLMV** is able to take Temperature readings from the Conductivity sensor or a separate Temperature sensor. Only one or the other can be connected at any one time. Ensure that the **90-FLMV** has been calibrated on the correct sensor.

9.1 Temperature Calibration

1. Plug the Conductivity sensor or separate Temperature sensor into the **Cond/Sal** socket.
2. Switch the meter on.
3. Place the sensor into a beaker of room temperature water, alongside a good quality mercury thermometer. Stir the sensor and the thermometer gently to ensure an even temperature throughout the beaker.
4. Select Temperature Calibration ( → **F1:Calibrate** → **F4:Temperature**).

The Temperature Calibration screen is now displayed...

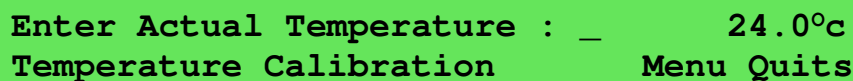



```

Enter Actual Temperature : _      24.0°C
Temperature Calibration      Menu Quits
  
```

5. The current reading from the sensor is displayed on the far right of the top line.

When this reading has stabilised, use the Numeric Keypad to enter the same temperature as measured by the mercury thermometer.

6. Press the  key to calibrate the temperature readout.

Alternatively, press the  key to abort temperature calibration.

The **90-FLMV** temperature is now calibrated. The following screen is displayed...



```

Calibration OK,              Offset=0.1°C
  
```

The **90-FLMV** will now return to normal measurement mode and the “*” in the Temperature readout will have been replaced by a decimal point.

9.2 Temperature Calibration Notes

1. Temperature calibration information is retained in memory when the **90-FLMV** is switched off. This information can be recalled later using the GLP function (see section 10).
2. Temperature does not need to be re-calibrated unless the Conductivity or Temperature sensor is replaced or the meter is initialised.

9.3 Calibration Messages

1. If a temperature calibration has been successfully performed, the **90-FLMV** will display the following message and the offset value of the sensor. The bottom line appears after 3 seconds.

```
Calibration OK,           Offset=0.1°C
```

2. If the temperature calibration has failed, the **90-FLMV** will display the following message and the failed offset value of the sensor.

```
Calibration Failed,      Offset=16.0°C
```

3. The **90-FLMV** has an allowable Offset range of -10.0 to +10.0 °C. If calibration fails due to the Offset being outside these limits, then please consult the Troubleshooting guide (section 18.5) for possible remedies.

9.4 Manual Temperature Setting

If a Conductivity or Temperature sensor is not connected, the temperature of the sample solution must be set manually for accurate ppM Dissolved Oxygen or pH measurements. A separate thermometer will be required for this. Temperature compensation is not applicable for Millivolt mode.

1. Switch the meter on.
2. Measure the temperature of the sample.
3. Select Temperature Calibration (Menu → **F1:Calibrate** → **F2:Temperature**).
4. The current temperature setting is now displayed. For example...

```
Enter Manual Temperature : 25.0 °C
                          Menu Quits
```

5. Enter the temperature of the sample, using the Numeric Keypad.
Press Enter to save the new value.
Alternatively, press Menu to quit and retain the current setting.
6. When returning to normal measurement mode, note the “**M**” in the temperature readout, indicating that Manual Temperature Compensation is in use. For example...

```
10.00ppM  2.76mS  7.00pH  1000mV  25.0°CM
  Oxy      Cond           31/12  12:00:00
```

10. Good Laboratory Practices (GLP)

The **90-FLMV** keeps a record of the date and time of the last calibrations for all parameters as part of GLP guidelines.

10.1 To recall GLP information on the display

1. Switch the meter on.
2. Select the GLP menu (Menu) → **F4: Setup** → **F2: GLP**).
3. Select **F1: Recall** from the menu.
4. The instrument model, firmware version number, and instrument serial number are displayed, along with a prompt describing how to scroll through the GLP information.

```
90FLMVm  V10.0 S1234      @ 31/12/00 12:00
                                     F4:Next
```

The “m” after the model name is displayed when the Dissolved Oxygen stirrer is enabled.

5. Press the (F4) key to sequentially scroll through the GLP information for all parameters. Press the (F2) key to scroll back to previous data. The sequence of information displayed is shown below. Press (Menu) to abort at any time.

GLP Display sequence...

```
90FLMVm  V10.0 S1234      @ 31/12/00 12:00
                                     F4:Next
```

↑(F2) ↓(F4)

```
Oxygen Zero=0.1%          31/12/00 12:00
Oxygen Calibrated         F2:Back F4:Next
```

↑(F2) ↓(F4)

```
Oxygen Span=100.0%       31/12/00 12:10
Oxygen Calibrated         F2:Back F4:Next
```

↑(F2) ↓(F4)

```
Cond. Zero=0.01uS        31/12/00 12:20
Cond Calibrated           F2:Back F4:Next
```

↑(F2) ↓(F4)

```
Cond. k=10.1             31/12/00 12:40
Cond Calibrated           F2:Back F4:Next
```

Continued over the page...

GLP Display sequence, continued...

↑^{F2} ↓^{F4}

pH Asymmetry=0.10pH 31/12/00 13:30
 pH Calibrated F2:Back F4:Next

↑^{F2} ↓^{F4}

pH Slope= 99.0% 31/12/00 13:40
 pH Calibrated F2:Back F4:Next

↑^{F2} ↓^{F4}

Temperature Offset=1.0°C 31/12/00 14:30
 Temp Sensor Calibrated F2:Back F4:Ends

10.2 Failed Calibration

If calibration has failed, the GLP function will reset the date and time for the failed parameter to zero. The **90-FLMV** still shows the results for the last successful calibration, as shown in the following example of a failed pH calibration....

pH Asymmetry= 0.10pH 00/00/00 00:00
 pH Un-Calibrated F2:Back F4:Next

10.3 Printing GLP Information to the RS232 Port

The GLP information stored in the instrument's memory can be sent to a printer or PC via the RS232 port.

1. Switch the meter on.
2. Connect one end of the RS232 cable to the **Charger** socket of the **90-FLMV**. The battery charger, optional battery adaptor, or optional solar panel may be connected to the in-line socket on the RS232 cable, if required.
3. Connect the other end of the RS232 cable to an RS232 Printer, or to the COM1 or COM2 ports of a PC.
4. Send the GLP information to the RS232 port:

Ⓜ → F4:Setup → F2:GLP → F3:Print (or Ⓜ)

The message "Printing GLP Data" is displayed while sending the data to the RS232 port.

5. The GLP information is sent to the RS232 port in formatted ASCII text. For example...

```
90FLMV V10.0 S1234 @ 31/12/2010 12:00
Oxygen      Zero=      0.1%      @ 31/12/2010 12:00
Oxygen      Span=     100.0%     @ 31/12/2010 12:10
Conductivity Zero=     0.01uS     @ 31/12/2010 12:20
Conductivity k=      1.01      @ 31/12/2010 12:30
pH          Asy=      0.10pH     @ 31/12/2010 13:20
pH          Slope=    99.0%     @ 31/12/2010 13:30
Temperature Offset=  1.0oC     @ 31/12/2010 14:20
Ends
```

10.4 Instrument Serial Number

In case the serial number that is fitted to the rear of the **90-FLMV** is removed or becomes illegible, it is also available on the **90-FLMV** display.

1. The serial number is displayed at turn-on, for example...

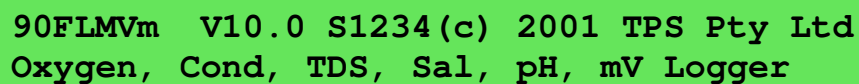

```
90FLMVm V10.0 S1234(c) 2001 TPS Pty Ltd
Oxygen, Cond, TDS, Sal, pH, mV Logger
```

The “m” after the model name is displayed when the Dissolved Oxygen stirrer is enabled.

2. The serial number is displayed when recalling the GLP information (section 10.1).
3. The serial number is included on the print-out of GLP information (section 10.3).
4. The GLP information can be downloaded to a PC using the optional Windows® software (part number 130086).

10.5 Additional GLP Features

Another GLP requirement is to record the date and time of every reading. The **90-FLMV** does this for you when readings are recorded either with the Manual Data logging function (section 11.2) or the Automatic Data logging function (section 11.3).

11. Data logging

11.1 Setting the A & B Data Input Function

The A & B Data Input function allows the operator to enter extra numerical data whenever data logging manually. The A & B Data Input function can also be set for any one of the following...

- “A” as Pond number with no extra “B” data input.
- “A” as Pond number with extra “B” data input.
- “A” as data input with no extra “B” data input.
- “A” and “B” both as data input.
- A & B Data Input Function switched OFF.

The Logger memory must be erased before changing the A & Data Input setting.

To set the A & B Data Input function...

1. Select the A & B setup menu (Menu) → **F4:Setup** → **F3:Set AB**). The **90-FLMV** will prompt you to erase the Logger before proceeding, if any data is stored in memory.

```

SET   F1:A=Pond, No B   F2:A=Pond, B=Data
A/B   F3:A=Data, No B   F3:A&B=Data >F5:OFF
  
```

The arrow indicates the current selection.

2. Press (F1) to set “A” as Pond number with no extra “B” data input.
 Press (F2) to set “A” as Pond number with extra “B” data input.
 Press (F3) to set “A” as data input with no extra “B” data input.
 Press (F4) to set “A” and “B” both as data input.
 Press (F5) to switch the A & B Data Input function OFF.
 Press (Menu) to quit and retain the current setting.
3. The A & B Data Input function is now set and is ready for use during Manual Data logging.

11.2 Manually Recording Readings into the Logger

11.2.1 When A & B Data Input has been set to OFF

1. Press (Store) in normal display mode. The display should now look like this...

```

10.00ppM  2.76mS   7.00pH  1000mV  25.0°C
Log#1,    <Enter>          31/12  12:00:00
  
```

2. Press (Enter) to record all parameters plus Date and Time into the Logger memory. This will be labelled as reading number 1.
 Alternatively, press (Menu) to quit without recording the reading.
3. Repeat steps 1 & 2 as often as required. The maximum number of readings that can be stored in the Logger with the A & B Data Input function switched OFF is 7230.

11.2.2 When A is set to Pond, with no extra B data

1. Press **(Store)** in normal display mode. The display should now look like this...

```
10.00ppM  2.76mS   7.00pH  1000mV  25.0°C
Log#1,    Pond#1           31/12 12:00:00
```

2. Use the numeric keypad to key in the Pond number, then press **(Enter)** to record all parameters, Date, Time and the Pond number into the Logger memory. This will be labelled as reading number 1.

Alternatively, press **(Menu)** to quit without recording the reading.

3. Repeat steps 1 & 2 as often as required.

The Pond number will automatically increment by one from the last recorded reading.

The maximum number of readings that can be stored in the Logger with this A & B Data Input setting is 5950.

11.2.3 When A is set to Pond, and B is set to data

1. Press **(Store)** in normal display mode. The display should now look like this...

```
10.00ppM  2.76mS   7.00pH  1000mV  25.0°C
Log#1,    Pond#1           31/12 12:00:00
```

2. Use the numeric keypad to key in the Pond number, then press **(Enter)** to record all parameters, Date, Time and the Pond number into the Logger memory. This will be labelled as reading number 1.

Alternatively, press **(Menu)** to quit without recording the reading.

3. The **90-FLMV** now proceeds to the B data entry screen...

```
Data Recorded, Now Input B or Press Menu
Enter Data B:0
```

Use the numeric keypad to key in up to four characters for the “B” data item. The decimal point is available. Press **(Enter)** to record the “B” data item, or press **(Menu)** to quit. Quitting at this point records a Zero as the “B” data item.

4. Repeat steps 1 to 3 as often as required.

The Pond number will automatically increment by one from the last recorded reading.

The maximum number of readings that can be stored in the Logger with this A & B Data Input setting is 5950.

11.2.4 When A is set to Data with no B data

1. Press **(Store)** in normal display mode. The display should now look like this...

```
10.00ppM  2.76mS   7.00pH  1000mV  25.0°C
Log#1,    <Enter>          31/12 12:00:00
```

2. Press **(Enter)** to record all parameters, plus Date and Time into the Logger memory. This will be labelled as reading number 1.

Alternatively, press **(Menu)** to quit without recording the reading.

3. The **90-FLMV** now proceeds to the A data entry screen...

```
Enter Data A:0
Data Recorded, Now Input A or Press Menu
```

Use the numeric keypad to key in up to four characters for the “A” data item. The decimal point is available. Press **(Enter)** to record the “A” data item, or press **(Menu)** to quit. Quitting at this point records a Zero as the “A” data item.

4. Repeat steps 1 to 3 as often as required.

The maximum number of readings that can be stored in the Logger with this A & B Data Input setting is 5950.

11.2.5 When A and B are both set to Data

1. Press **(Store)** in normal display mode. The display should now look like this...

```
10.00ppM  2.76mS   7.00pH  1000mV  25.0°C
Log#1,    <Enter>          31/12 12:00:00
```

2. Press **(Enter)** to record all parameters, plus Date and Time into the Logger memory. This will be labelled as reading number 1.

Alternatively, press **(Menu)** to quit without recording the reading.

3. The **90-FLMV** now proceeds to the A data entry screen...

```
Enter Data A:0
Data Recorded, Now Input A or Press Menu
```

Use the numeric keypad to key in up to four characters for the “A” data item. The decimal point is available. Press **(Enter)** to record the “A” data item, or press **(Menu)** to quit. Quitting at this point records Zero’s as the “A” and “B” data items.

4. The **90-FLMV** now proceeds to the B data entry screen...

```
Enter Data A:1234
Enter Data B:0
```

Use the numeric keypad to key in up to four characters for the “B” data item. The decimal point is available. Press **(Enter)** to record the “B” data item, or press **(Menu)** to quit. Quitting at this point records a Zero as “B” data item.

5. Repeat steps 1 to 4 as often as required. The maximum number of readings that can be stored in the Logger with this A & B Data Input setting is 5950.

11.3 Automatic Data logging

The **90-FLMV** can automatically log records into the Logger. There are two automatic data logging modes to choose from...

1. Rate Per Day
 - Logs from 1 to 288 readings per day, evenly spaced throughout each 24 hour period.
 - Unit is dormant between readings and “wakes up” when a reading is due.
 - Dissolved Oxygen stirrer is switched on for 40 seconds before each reading is logged (if Dissolved Oxygen stirrer output is enabled).
 - Unit continues to log until automatic data logging is disabled, or until the memory is full.
2. Sampling Period and Duration
 - Logs a reading every 1 to 300 seconds for a duration of 1 to 720 minutes.
 - Duration can be set to log continuously until the memory is full.
 - Unit is turned on continuously in this logging mode.
 - Dissolved Oxygen stirrer is switched on continuously in this logging mode (if Dissolved Oxygen stirrer output is enabled).

The automatic data logging parameters of the **90-FLMV** must first be programmed, then logging can be started and stopped as required.

11.3.1 Rate per Day Data logging

Programming Rate per Day Data logging

1. Select the Logger Program menu (Menu) → **F3:Logger F5:Program**)
2. Select **F1:Rate per Day** from the menu.

The display should now look similar to that shown below. The current Rate per Day is displayed...

Number of Readings per Day : 24

3. Use the Numeric Keypad to set the number of readings per day which the **90-FLMV** will automatically log into memory. This can be set from 1 to 288 (ie. 1 reading every 24 hours to 1 reading every 5 minutes).
Press (Enter) to save the Rate per Day.
Press (Menu) to quit without changing the current setting.
4. The Rate per Day data logging is now programmed, and can be started and stopped as required.

Notes

1. The **90-FLMV** distributes the number of readings evenly throughout a 24 hour clock cycle, regardless of what time automatic logging is started and stopped. For example, if the **90-FLMV** is programmed to log 4 readings per day, they will be logged at 24:00, 6:00, 12:00 and 18:00 o'clock.

Starting and Stopping Rate per Day Data logging

Starting Rate per Day data logging is a two step process...

1. Select the Logger menu (Menu) → **F3:Logger**)
Select **F4:Start** from the menu.
2. Switch the **90-FLMV** OFF.
This step is essential, as the Rate per Day data logging is only enabled when the **90-FLMV** is switched OFF.

Stopping Rate per Day data logging is a one step process...

1. Select the Logger menu (Menu) → **F3:Logger**)
Select **F4:Stop** from the menu.

Notes

1. The **90-FLMV** remains dormant between readings and only switches itself ON when a reading is due.
2. If the Dissolved Oxygen stirrer is enabled, it is switched on for 40 seconds before the reading is recorded.
3. The **90-FLMV** is switched on 3 minutes before the next reading is due to ensure that the Dissolved Oxygen sensor is fully polarised. The unit will therefore not automatically log any readings for at least 3 minutes after it has been switched OFF, even if a reading is due during that time.

11.3.2 Sampling Period and Duration Data logging

Programming Sampling Period and Duration Data logging

1. Select the Logger Program menu (Menu) → **F3:Logger F5:Program**)
2. Select **F3:Sampling Period and Duration** from the menu.
3. The **90-FLMV** now prompts you to enter the sampling period in seconds. The current sampling period is displayed...

Enter Sampling Period (secs) : 5

Use the Numeric Keypad to set the **90-FLMV** to log a reading every 1 to 300 seconds.

Press (Enter) to save the new sampling period and move to setting the duration.

Press (Menu) to retain the previous sampling period and move to setting the duration.

4. The **90-FLMV** now prompts you to enter the duration in minutes. The current duration is displayed...

Enter Duration of Sampling (mins) : 10
Enter 0 for continuous

Use the Numeric Keypad to set the total duration for which the **90-FLMV** will log readings into memory from 1 to 720 minutes. Alternatively, enter 0 to log continuously until logging is stopped by the user or the memory is full.

Press (Enter) to save the new duration.

Press (Menu) to quit and retain the previous duration.

5. The Sampling Period and Duration data logging is now programmed, and can be started and stopped as required.

Starting and Stopping Sampling Period and Duration Data logging

Starting and stopping Sampling Period and Duration data logging is a two step process...

1. Press (F4) in normal measurement mode.
2. The **90-FLMV** now prompts you to press (Enter) to begin logging. For example...

**Press Enter to Sample every 5 seconds,
For 10 minutes, or Menu to Quit 12:00:00**

The time is shown to enable the user to synchronise the sampling times if required.

1. Press (Enter) to start logging.

To stop logging before the end of the duration press (F4).

Notes

1. The **90-FLMV** remains switched on continuously for Sampling Period and Duration data logging.
2. If the Dissolved Oxygen stirrer is enabled, it is switched on continuously for Sampling Period and Duration data logging.

11.4 Recalling Readings from the Logger

To recall records from the Logger onto the 90-FLMV display...

1. Select the Logger menu (Menu → **F3:Logger**)
2. Select **F1:Recall** from the menu.

Record number 1 is now displayed.

The following example shows the display when the A & B Data Input function was switched off during logging...

```

10.00ppM  2.76mS  7.00pH  1000mV  25.0°C
Log#1      F2:↑ F4:↓      31/12 12:00:00
  
```

The following example shows the display when “A” and “B” were both set to data during logging...

```

10.00ppM  2.76mS  7.00pH  1000mV  25.0°C
Log#1      A=1234  B=1234  31/12 12:00:00
  
```

3. Press **F2** to display the next record.
 Press **F4** to display the previous record.
 Press and hold **F2** or **F4** to scroll continuously through the readings.
 To display a specific record, type in the desired record number using the Numeric Keypad and press **Enter**.
 Press **Print** to send the displayed record to the RS232 port.

11.5 Erasing Records from the Logger

To erase records from the Logger...

1. Select the Erase Logger menu (Menu → **F3:Logger** → **F2:Erase**)
2. The **90-FLMV** now displays the Erase menu, for example...

```

Erase Logger, ( 100 ) Select Option
F1:Erase All  F2:Erase Last  Menu Exits
  
```

The number of readings stored in the Logger is displayed. See the “100” in the example above.

3. Press (F1) to erase all of the readings stored in the Logger.
Press (F2) to erase the last recorded reading only.
Press (Menu) to quit without erasing any records.

11.6 Printing Records from the Logger to the RS232 Port

1. Connect one end of the RS232 cable to the **Charger** socket of the **90-FLMV**.
2. Connect the other end of the RS232 cable to an RS232 Printer, or to the COM1 or COM2 ports of a PC.
3. Ensure that the baud rate for the printer or PC and the **90-FLMV** are the same. If necessary, alter the baud rate of the **90-FLMV** (see section 12.1).

The **90-FLMV** uses XON/XOFF protocol. Ensure that the printer is set accordingly.

4. Select the Logger menu. (Menu → **F3:Logger**).
5. Select **F3:Print Log** from the menu or press (Print).
6. Printing starts as soon as (F3) or (Print) is pressed. The display shows the word “**Printing**” until printing is completed.

12. RS232 Port

12.1 Setting the Baud Rate

1. Select the Baud Rate menu (Menu) → **F5:System** → **F3:Baud Rate**)
2. The available baud rates are listed, along with the RS232 port configuration...

```
Baud Rate:  F1:300 >F2:9600  F3:19200
8 bits, No Parity, 1 Stop bit, XON/XOFF
```

The arrow indicates the current selection.

3. Press (F1) to select 300 baud.
Press (F2) to select 9600 baud.
Press (F3) to select 19200 baud.
Press (Menu) to quit and retain the current setting.

12.2 Sending Readings to the RS232 Port

Press (Print) to instantly send readings to the RS232 port whenever the **90-FLMV** is in normal display mode.

Each time the **90-FLMV** logs a reading, that reading is sent directly to the RS232 port.

Press (Print) while recalling data on the display (see section 11.4) to send that record to the RS232 port.

12.3 RS232 Configuration

The **90-FLMV** RS232 configuration is 8 Bits, No Parity, 1 Stop Bit, XON/XOFF Protocol.

This information is displayed when setting the baud rate (see section 12.1)

12.4 Communication and Statistical Software

Communication between the **90-FLMV** and a PC can be handled with any RS232 communication software. A TPS communication software package for Windows® is optionally available (part number 130086).

Once the data is saved to disk, the next problem is how to use it. The data sent by the **90-FLMV** is formatted in fixed-width columns that can be imported by programs such as Microsoft® Excel® and Lotus 123®.

Help on importing the data into Microsoft® Excel® is provided in section 12.8 and the “excel.txt” file in the folder where you installed the WinTPS program.

12.5 Commands

The following commands can be sent from a PC to the **90-FLMV**. Note that <cr> denotes carriage return and <lf> denotes a line feed.

Action	Command	Notes
Request current data	?D<cr>	Returns the current data of all parameters plus date and time from the 90-FLMV . The log number returned is set to Zero.
Request logged data	?R<cr>	Returns all logged records from the 90-FLMV memory. The data ends with the message ENDS<cr> .
Erase logged data	?E<cr>	Erases all logged records from the 90-FLMV memory. Returns the message ERASED<cr> to confirm that the records have been erased.

Continued over the page...

RS232 Commands, continued...

Request status information	?S<cr>	Returns the model name, firmware version number, instrument serial number and number of logged readings in memory, for example... 90FLMV•V10.0•S1234•7230•mASLB+v%<cr> where • are spaces. Note that the number of logged readings is right-justified. The meaning of the last group of characters is as follows...
		m Dissolved Oxygen stirrer output is enabled.
		A or P A indicates A & B function is enabled. P indicates A is set to Pond Number.
		S Unit is powering Dissolved Oxygen stirrer.
		L Automatic data logging is enabled.
		B Low Battery warning.
		+ Extended data logging function is fitted.
		v Battery volts is available with ?V command.
	% Indicates new 90 series, V10.0 and up.	
Request GLP information	?G<cr>	Returns all calibration GLP information, plus the instrument model, serial number and current date (see section 12.7 for data format and hand-shaking).
Enable Rate per Day or Time of Day automatic data logging	?J<cr>	Starts automatic data logging when the 90-FLMV is set up for Rate per Day or Time of Day automatic data logging (see section 11.3.1). The meter must then be powered down with the OFF key or with the ?K command (see below).
Disable Rate per Day or Time of Day automatic data logging	?F<cr>	Stops automatic data logging when the 90-FLMV is set up for Rate per Day or Time of Day automatic data logging (see section 11.3.1).
Power ON	Any 10 characters	Switches the 90-FLMV ON. A specific command is not available while the 90-FLMV is off, so RS232 activity caused by the 10 characters switches the unit ON.
Power OFF	?K<cr>	Switches the 90-FLMV OFF. Use the command after the ?G command (above) to actually start rate per Day or Time of Day automatic data logging.
Turn Dissolved Oxygen stirrer ON	?M<cr>	Starts the Dissolved Oxygen stirrer to run continuously until stopped. The stirrer output must be enabled (see section 3.5.1)
Turn Dissolved Oxygen stirrer OFF	?N<cr>	Stops the Dissolved Oxygen stirrer.
Request battery volts	?V<cr>	Returns the current voltage level in the battery pack, for example... 7.20V<cr>
Positions of Data Fields	?P<cr>	Returns the number of data fields, along with their position and length. When the A&B Data Input function is disabled... 8, 1, 10, 12, 8, 21, 4, 26, 5, 35, 7, 46, 5, 54, 5, 62, 5 This denotes 8 fields, the first of which is at column 1 and is 10 characters long. The second field is at column 12 and is 8 characters long and so on. When the A&B Data Input function is enabled... 10, 1, 10, 12, 8, 21, 4, 26, 5, 35, 7, 46, 5, 54, 5, 62, 5, 70, 4, 76, 4
Data Column Header	?H<cr>	Returns a text string which can be used to provide headers for each data field. Spaces are included to ensure that the headers are correctly aligned with the data.

12.6 Data Format

Data is returned to the RS232 Port by the **90-FLMV** in the following format.

Please note that a “ • ” shown anywhere in this section denotes one space.

dd/mm/yyyy•hh:mm:ss•LLLL•DDDDDuuu•CCCCCCuuu•PPPPUuu•MMMMuu•TTTTTuLaaaaA•bbbbB

where....

dd/mm/yyyy is the date, month and year data.

hh:mm:ss is the hours, minutes and seconds data.

LLLL is the Log Number, 4 characters, right justified. The **90-FLMV** sends a Zero for instant readings (see section 12.2).

DDDDD is Dissolved Oxygen data. 5 characters, right justified.

uuu is the Dissolved Oxygen units description, which can be any of the following...

ppm	for parts per Million readout without Salinity correction. Note the lower case “m”.
ppM	for parts per Million readout with Salinity correction applied. Note the upper case “M”.
%S•	for % Saturation readout.
%G•	for % Gaseous readout.

CCCCCC is Conductivity or TDS or Salinity data. 7 characters, right justified.

uuu is the Conductivity or TDS or Salinity units description, which can be either of the following...

uS•	for μ S/cm Conductivity readout. All readings are converted to μ S/cm to ensure that the data is logical when analysed with other programs.
ppM	for parts per Million TDS readout. All readings are converted to ppM to ensure that the data is logical when analysed with other programs.
%••	for PSU Salinity readout.
PSU	for percent Salinity readout.

PPPPP is pH data. 5 characters, right justified.

uu is the pH unit description, sent as “pH”.

MMMM is mV data. 5 characters, right justified.

uu is the mV unit description, sent as “mV”.

TTTTT is Temperature data, 5 characters, right justified.

uu is the Temperature unit description. Sent as “oC” for measured temperature data, or “oM” for manual temperature data.

L is the Low Battery indicator. Sent as “L” when the battery is below 5.60 volts.

The **90-FLMV** sends a space when the battery is above 5.60 volts.

Continued over the page...

Data format, continued...

aaaa	A-Data input, 4 characters, left justified.
A	A-Data input identifier. Sent as “ A ” for A-Data or “ P ” for Pond number. See section 11.1 for further details on the A and B Data input function.
bbbb	B-Data input, 4 characters, left justified.
B	B-Data input identifier. Sent as “ B ”. See section 11.1 for further details on the A and B Data input function.

Notes

1. The “**aaaaA**” and “**bbbbB**” sections of the data string are not sent at all when the A and B data input function is switched off (see section 11.1).
2. When requested by a PC with the ?D or ?R commands (section 12.5), the data is terminated with a carriage return.
3. When the data is sent by the **90-FLMV** using the Print function (section 11.6) or the Instant Send function (section 12.2), the data ends with a carriage return and a line feed.

12.7 GLP Data Format

GLP information is returned as 12 lines terminated by a carriage return. When using the “?G” command (section 12.5), the computer must respond with a character after receiving each line.

For example...

```

90FLMV V10.0 S1234 @ 31/12/2010 12:00
Oxygen      Zero=      0.1%      @ 31/12/2010 12:00
Oxygen      Span=      100.0%     @ 31/12/2010 12:10
Conductivity Zero=     0.01uS    @ 31/12/2010 12:20
Conductivity k=      1.01      @ 31/12/2010 12:30
pH          Asy=      0.10pH    @ 31/12/2010 13:20
pH          Slope=     99.0%     @ 31/12/2010 13:30
Temperature Offset=    1.0oC     @ 31/12/2010 14:20
Temperature Span=    100.0%    @ 31/12/2010 14:30
Ends

```

12.8 Importing Data into Microsoft Excel

The following procedure details the method for importing a **90-FLMV** text data file into Microsoft® Excel®.

1. Start Microsoft® Excel® and select File → Open
2. In the “Files of type:” pull-down box, choose “Text Files (*.prn; *.txt; *.csv)”.
3. Navigate to the folder where your data file is stored and double-click it to start the Text Import Wizard.

Note : The default data folder for the WinTPS software is “C:\My Documents\WinTPS”.

4. In step 1 of the Text Import Wizard select “Fixed width”, as per the sample screen below, then press “Next >”.

Note that the data column headers in row appear only when the data is downloaded using the WinTPS software.

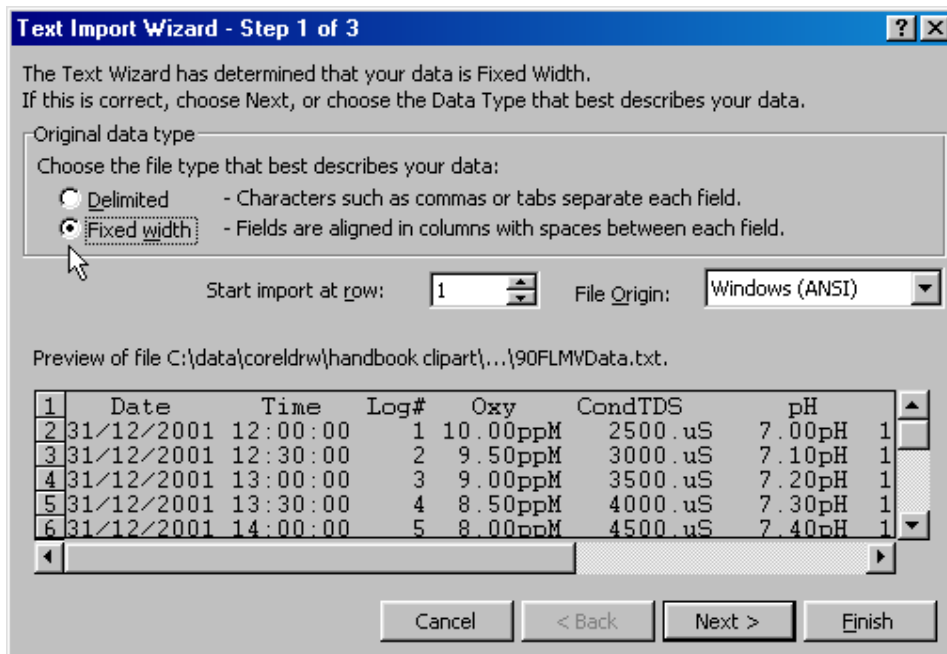

Continued over the page...

5. Step 2 of the Text Import Wizard allows you to select the points at which each data field will break into a new column. The sample screens below show where TPS recommends the breaks be inserted. There are two screens, as the width of the data requires the window to be scrolled over.

The date and time have been incorporated into a single column to ensure that the X-axis is correctly formatted if the data is to be charted later.

Press “Next >” after all the column breaks have been inserted.

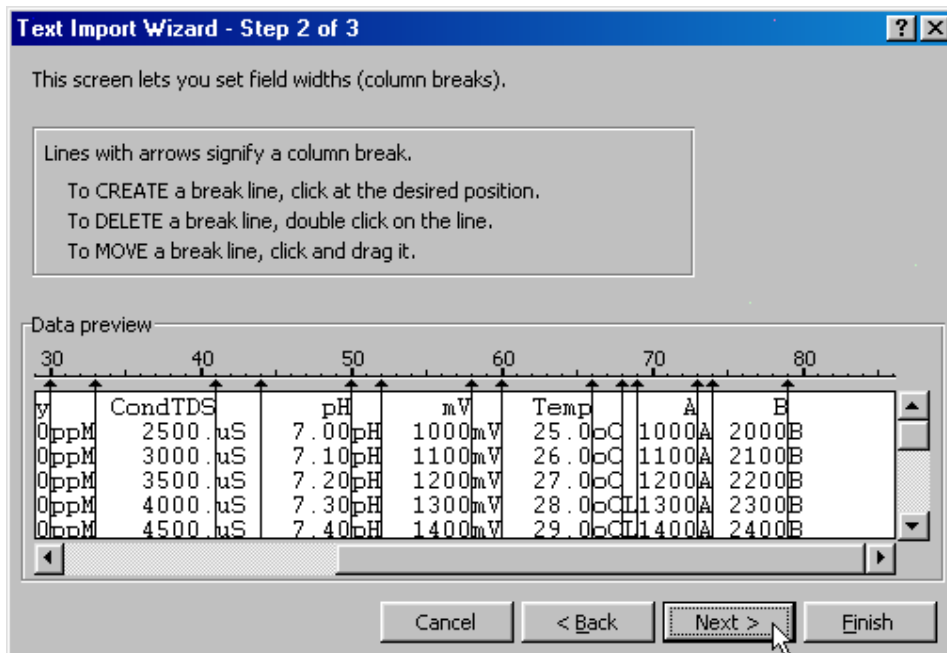
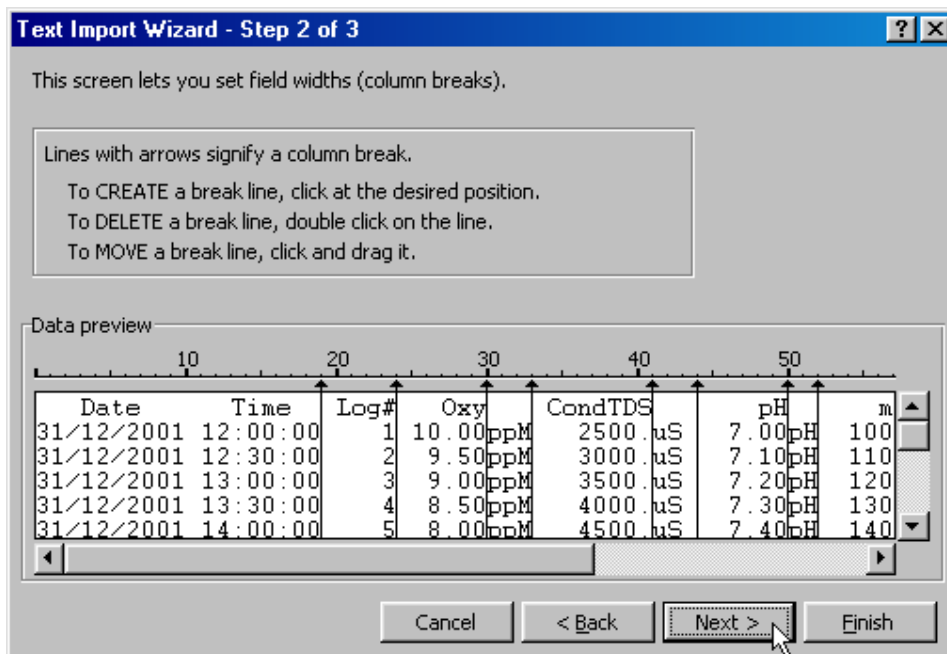

6. Simply press “Finish” at step 3 of the Text Import Wizard. TPS recommends that the data format for each column be set once the data is in spreadsheet format.

For help on formatting the data columns, charting, graphing or other operations please consult the Microsoft® Excel® help file. Alternatively please contact TPS and we will try to provide further assistance.

13. Setting the Clock

1. Select the Clock Set-up menu (Menu → F5:System → F2:Set Clock)
2. The display now shows the current time, for example...

```
Time is now      12:00
Enter new Time  12:00
```

3. Use the Numeric Keypad to enter the current time in 24 hour format, then press (Enter).
Alternatively, press (Menu) to quit and retain the current setting.
4. If you pressed (Enter) above, the display will now show the current date, for example...

```
Date is now      31/12/2010
Enter new Date   31/12/2010 dd/mm/yyyy
```

5. Use the Numeric Keypad to enter the current date in dd/mm/yyyy format, then press (Enter).
Alternatively, press (Menu) to quit and retain the current setting.

Notes

1. Press the (←) key to make any corrections as required.
2. The **90-FLMV** tests that a valid time of the day is entered. If an invalid time is entered (eg. 25:00), the **90-FLMV** displays the message “**Invalid Time**”, then returns to the time setting screen so that the correct time can be entered.
3. The **90-FLMV** tests that a valid day of the month is entered. If an invalid date is entered (eg. 31/02/2010), the **90-FLMV** displays the message “**Invalid Date**”, then returns to the date setting screen so that the correct date can be entered.
4. The **90-FLMV** also tests for leap years.

14. Initialising the 90-FLMV

If the calibration settings of the **90-FLMV** exceed the allowable limits, the unit may need to be initialised to factory default values. This action may be required if a sensor is replaced or if the memory is corrupted.

To initialise the **90-FLMV**...

1. Select the GLP menu (Menu) → **F4:Setup** → **F2:GLP**).
2. Select **F4:Initialise Meter** from the menu.
3. The **90-FLMV** will now ask if you are sure that you wish to initialise the unit...

Initialise Unit, Are you sure ?
F1:Yes F2:No

Press (F1) to initialise the **90-FLMV** and reset all calibration data and erase all logged readings.

Press (F2) to quit and retain the current calibration settings and logged readings.

4. If **F1:Yes** was selected above, the **90-FLMV** will display the number of logged readings in memory and provide an additional warning that these will be erased. For example...

Logger contains Data. 7230 readings
will be Erased. Continue ? F1:Yes F2:No

Press (F1) to initialise the **90-FLMV** and reset all calibration data and erase all logged readings.

Press (F2) to quit and retain the current calibration settings and logged readings.

5. If **F1:Yes** was selected above, the **90-FLMV** will display the following messages to indicated that the unit has been successfully initialised.

Initialising

then...

Initialised
Re-Calibrate unit before use.

6. The meter then goes back to the GLP menu. When returning to display mode later, note that each of the decimal points has been replaced with a “ * ” to indicate that each parameter requires re-calibration.

15. Instrument firmware version number

If you need to email TPS for any further technical assistance, the version number of your **90-FLMV** firmware may of benefit to us. The version number is displayed by the **90-FLMV** at turn-on.

16. Battery Saver Function

The **90-FLMV** is equipped with a battery saver function. If no button has been pressed for 5 minutes or 1 hour, the unit beeps and flashes the display for 20 seconds and then shuts off. This function can also be switched off for continuous use.

To program the battery saver function:

1. Select Battery Saver menu (Menu) → **F5: System** → **F1: Bat. Saver**).
2. The battery saver menu is now displayed...

Battery Saver:	F1: OFF	>F2: 5 minutes
Volts= 7.20V	F3: 1 hour	

The arrow indicates the current selection.

3. Press (F1) to disable the battery saver function for continuous use.
 Press (F2) to set the battery saver function to 5 minutes. The meter will switch itself off if no key has been pressed for five minutes.
 Press (F3) to set the battery saver function to 1 hour. The meter will switch itself off if no key has been pressed for 1 hour.
 Press (Menu) to quit the battery saver menu and retain the current setting.

Notes

1. The  symbol flashes when the battery volts drops below 5.60 volts. At approximately 5.10 volts the meter turns itself off.

17. Moisture Protection

17.1 Silica Gel Pack

Due to the size of the **90-FLMV** enclosure, it tends to expand in hot environments and contract in cold environments. This process can cause moist air to be drawn into the enclosure, which would then cause corrosion damage to the circuit.

To avoid this problem, TPS has mounted a breathing system inside the enclosure. This system consists of a long, thin tube which is vented to the atmosphere at one end and into a bottle of Silica gel at the other end. This ensures that the **90-FLMV** breathes dry air. In humid environments, the Silica gel pack should be regularly checked.

To check the Silica gel pack...

1. Undo the 4 plastic screws on the rear of the unit.
2. Inspect the bottle of Silica gel.

Blue indicates that the Silica gel is still dry (proceed to step 5).

Pink indicates that the Silica gel is moist (proceed to step 3).

3. Empty the Silica gel into a microwave proof dish and place it into a microwave oven.

Place approximately 100mL water in a microwave proof cup into the microwave oven. This will absorb some of the microwave energy and stop the Silica gel balls bursting.

Turn the microwave oven ON using a moderate setting for approximately 1 minute, or until the Silica gel turns blue.

CAUTION : THE SILICA GEL MAY BE VERY HOT AT THIS POINT.

4. Remove the Silica gel from the microwave oven and allow to cool.
Pour the Silica gel back into the bottle and re-fit the bottle onto the rear cover of the instrument.
5. Re-fit the rear cover onto the instrument, ensuring that is the correct way around. The cover has locating lugs in two of the corners to make correct fitment simple.

18. Troubleshooting

18.1 General Errors

Error Message	Possible Causes	Remedy
Factory Calibration Data Failure	The EEPROM chip which contains the factory calibration information has failed.	The unit must be returned to TPS for service.
EEPROM Write Failure Return to Factory for Service	User calibration settings have been lost or corrupted.	Switch the meter OFF and switch back ON. If the problem persists, return the unit to TPS for service.
Flashing  symbol.	Battery is below 5.60 volts.	Recharge the battery. A full charge will take approximately 18 hours. Note that the unit will switch itself off when the battery falls below 5.10 volts.
Meter displays the word OFF , and switches off.	Battery is below 5.10 volts.	Recharge the battery. If this fails, check the charger. If charger is OK, replace the battery.
Meter will not turn on.	Battery is exhausted.	Recharge the battery for approximately 18 hours. If this fails, check the charger. If charger is OK, replace the battery.
Battery does not charge up when charger is connected.	<ol style="list-style-type: none"> 1. Faulty battery charger. 2. Faulty battery. 	<ol style="list-style-type: none"> 1. Connect the charger and switch the power on. 2. Display the battery volts in the battery saver menu (see section 16). 3. If the battery volts are increasing then the charger is OK. If the battery volts do not increase, then the charger is faulty. 4. Replace the charger or the battery, as required.

18.2 Dissolved Oxygen Troubleshooting

Symptom	Possible Causes	Remedy
Unit fails to calibrate, even with new sensor.	Calibration settings outside of allowable limits due to previous failed calibration.	Initialise the unit. See section 14.
<ul style="list-style-type: none"> • Zero calibration fails (Zero is greater than 7.0%) • Air calibration fails (Span is less than 65% or greater than 200%). • Unstable or inaccurate readings. 	<ol style="list-style-type: none"> 1. Membrane is leaking or broken. 2. Gap between membrane and gold cathode is dry. 3. Incorrectly fitted membrane. 4. Sensor is empty. 5. Sensor is faulty. 	<p>Replace membrane and refill sensor.</p> <p>Gently pump the pressure compensation diaphragm several times.</p> <p>Membrane should be smooth and convex with no wrinkles. Re-fit membrane if necessary.</p> <p>Replace membrane and re-fill sensor.</p> <p>Return sensor to factory for repair or replacement</p>
Blackened Silver anode.	Sensor has been exposed to sulphides or other chemical poisoning.	<p>Remove pressure compensation diaphragm and membrane, then soak in 5% Ammonia solution for 10 minutes.</p> <p>If cleaning is unsuccessful, return the sensor to the TPS factory for cleaning and service.</p>
Tarnished or scratched Gold cathode.	Sensor has been chemically poisoned or physically damaged.	Return to the TPS factory for cleaning and service.
Dissolved Oxygen reading flashes in ppm mode.	Salinity reading is in excess of 50ppK.	Dissolved Oxygen readings are still valid and accurate, but no longer salinity-compensated, as the Salinity has exceeded the limit for accurate calculations.
Meter displays OVR ppm or OVR% instead of Dissolved Oxygen data.	<ol style="list-style-type: none"> 1. Sensor has not yet polarised. 2. Sensor is faulty 	<p>Wait for 2-3 minutes for the sensor to polarise after the 90-FLMV is switched on.</p> <p>Return sensor to factory for repair or replacement.</p>
Display flashes "ATC" and "LIMIT"	The Temperature is not within the ATC limits.	Cool/Heat solution before taking measurements.

18.3 Conductivity/TDS/Salinity Troubleshooting

Symptom	Possible Causes	Remedy
Unit fails to calibrate, even with new sensor.	Calibration settings outside of allowable limits due to previous failed calibration.	Check that the k factor is set correctly when not using a TPS k=10 sensor. Initialise the unit. See section 14.
Unit attempts Span calibration instead of Zero calibration.	Sensor has Zero error.	Thoroughly rinse sensor in distilled water and allow to completely dry in air before attempting zero calibration. DO NOT rub the platinised sensor surfaces. If instrument does not calibrate at Zero with sensor disconnected, then the instrument is faulty.
Standard calibration fails, and k factor is greater than 25% <i>above</i> the nominal value.	<ol style="list-style-type: none"> 1. Sensor is not immersed correctly. 2. Sensor may have a build-up of dirt or oily material on sensor plates. 3. Platinum-black coating has worn off. 4. Standard solution is inaccurate. 5. Sensor is faulty. 6. Faulty instrument. 	<p>Immerse sensor correctly as per diagrams in section 4.4.</p> <p>Clean sensor as per the instructions detailed in section 19.2.1.</p> <p>Sensor requires replatinization as per section 19.2.1. Alternatively, return to the factory for replatinization.</p> <p>Replace standard solution.</p> <p>Return sensor to factory for repair or replacement.</p> <p>Return to factory for repair.</p>
Standard calibration fails, and k factor is greater than 25% <i>below</i> the nominal value.	<ol style="list-style-type: none"> 1. Standard solution is inaccurate. 2. Sensor may have a build-up of conductive material, such as salt. 3. Sensor is faulty. 4. Faulty instrument. 	<p>Replace standard solution.</p> <p>Clean sensor as per the instructions detailed in section 19.2.1.</p> <p>Return sensor to factory for repair or replacement.</p> <p>Return to factory for repair.</p>
Inaccurate readings, even when calibration is successful.	<ol style="list-style-type: none"> 1. Sensor may have a build-up of dirt or oily material on sensor plates. 2. Platinum-black coating has worn off. 	<p>Clean sensor as per the instructions detailed in section 19.2.1.</p> <p>Sensor requires replatinization as per section 19.2.1. Alternatively, return to the factory for replatinization.</p>
Readings drift.	Sensor may have a build-up of dirt or oily material on sensor plates.	Clean sensor as per the instructions detailed in section 19.2.1.
Readings are low or near zero.	<ol style="list-style-type: none"> 1. Sensor may have a build-up of dirt or oily material on sensor plates. 2. Sensor is not immersed correctly. 3. Sensor is faulty. 4. Faulty instrument. 	<p>Clean sensor as per the instructions detailed in section 19.2.1.</p> <p>Immerse sensor correctly as per diagrams in section 4.4.</p> <p>Return sensor to factory for repair or replacement.</p> <p>Return to factory for repair.</p>
Display flashes "ATC" and "LIMIT"	The Temperature is not within the ATC limits.	Cool/Heat solution before taking measurements.

18.4 pH and ORP Troubleshooting

Symptom	Possible Causes	Remedy
Unit fails to calibrate, even with new pH sensor.	Calibration settings outside of allowable limits due to previous failed calibration.	Switch the unit OFF and then back ON again and repeat calibration. Initialise the unit. See section 14.
1 Point calibration fails (pH asymmetry is greater than ± 1.00 pH.)	<ol style="list-style-type: none"> Reference junction blocked. Reference electrolyte contaminated. 	<p>Clean reference junction as per instructions supplied with the pH or reference sensor.</p> <p>Flush with distilled water and replace electrolyte.</p>
2 Point calibration fails. (pH slope is less than 85.0%.)	<ol style="list-style-type: none"> pH Buffers not correctly set. pH glass bulb not clean. Sensor is aged. Connector is damp. pH Buffers are inaccurate. 	<p>For automatic pH buffer recognition, ensure that you are using buffers that match the selected buffer set (see section 7.1). Otherwise, ensure that the buffer value is entered correctly at pH calibration.</p> <p>Clean sensor surface or glass bulb as per instructions supplied with the sensor.</p> <p>Attempt rejuvenation as per instructions supplied with the sensor. If unsuccessful, replace sensor.</p> <p>Dry in a warm place.</p> <p>Replace buffers.</p>
Unstable readings.	<ol style="list-style-type: none"> Reference Electrolyte chamber needs to be refilled. Reference junction blocked. pH glass bulb or ORP platinum tip not clean. Bubble in pH glass bulb. Faulty connection to meter. Reference junction not immersed. KCl crystals around reference junction inside the electrolyte chamber. 	<p>Refill with saturated KCl filling solution.</p> <p>Clean reference junction as per instructions supplied with the sensor.</p> <p>Clean glass bulb or platinum tip as per instructions supplied with the sensor.</p> <p>Flick the sensor to remove bubble.</p> <p>Check connectors. Replace if necessary.</p> <p>Ensure that the reference junction is fully immersed. See diagrams in sections 7.2 or 8.1.</p> <p>Rinse electrolyte chamber with warm distilled water until dissolved. Replace electrolyte.</p>
Inaccurate readings, even when calibration is successful.	Reference junction blocked.	Clean reference junction as per instructions supplied with the sensor.
Displays constant reading around pH7.00 or 0 mV for all solutions.	Electrical short in connector.	<ol style="list-style-type: none"> Check connector. Replace if necessary. Replace sensor.
Displays 4-5 pH for all solutions.	pH sensor glass bulb or internal stem cracked.	Replace pH sensor.
Display flashes "ATC" and "LIMIT"	The Temperature is not within the ATC limits.	Cool/Heat solution before taking measurements.

18.5 Temperature Troubleshooting

Symptom	Possible Causes	Remedy
Temperature inaccurate and cannot be calibrated.	<ol style="list-style-type: none"> 1. Faulty connector. 2. Faulty Conductivity or Temperature sensor, whichever is being used. 	<p>Check the connector and replace if necessary.</p> <p>Return Conductivity or Temperature sensor for repair, or replace sensor.</p>
Displays manual temperature setting (eg. 25.0°C) when Conductivity or Temperature sensor plugged in.	<ol style="list-style-type: none"> 1. Faulty instrument socket. 2. Faulty Conductivity or Temperature sensor, whichever is being used 	<p>Return the instrument to the TPS factory for service.</p> <p>Return Conductivity or Temperature sensor for repair, or replace sensor.</p> <p>NOTE Conductivity readings may still be accurate, as there is a separate temperature sensor to provide ATC for this parameter built into the Conductivity sensor.</p>

19. Appendices

19.1 Dissolved Oxygen

19.1.1 Dissolved Oxygen Sensor Fundamentals

The sensor used is the amperometric type of Clark Sensor and is suitable for the measurement of oxygen pressures in the range 0 to 100 cm of mercury. While the sensor actually reads partial pressure of oxygen, the circuit is calibrated to be read in percentage saturation or parts per million (Milligrams/litre). The operation of the Clark type sensor relies on the diffusion of oxygen through a suitable membrane into a constant environment of potassium chloride. Solution measurements are best performed with a reasonable flow past the membrane. At sufficiently high flow rates, the oxygen current is totally independent of the flow (a few cm/sec is sufficient). The cell must not be shaken however or unstable readings will result from electrolyte surge bringing new oxygen from the reservoir to the working cathode surface.

19.1.2 Operating Principle

The Clark oxygen sensor consists of a gold cathode and a silver/silver chloride anode, placed in an electrolyte solution. This solution is contained behind a plastic membrane. In this case the plastic is 0.001 inch PTFE (Teflon) sheet. It must be realised that using membranes of very different thicknesses will result in an error in the temperature compensation that is applied in the instrument for the membrane permeability. This coefficient is +4.2%/°C at 25°C for this thickness membrane.

A polarising voltage of about 800 millivolts is applied between the two electrodes. The gold cathode is placed close to the membrane and because of the polarising voltage, oxygen diffusing through the membrane will be reduced at the gold cathode.

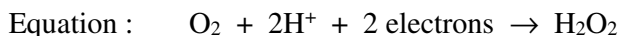

This reduction process will produce a current through the oxygen electrode. A load resistor (actually a thermistor in this case) situated in the sensor itself, converts this current into a voltage proportional to the oxygen partial pressure. The thermistor provided within the body of the sensor has a temperature coefficient of -4.2%/°C. This gives an accurate temperature compensation for the temperature/permeability effect of the membrane, over a range of about 5 to 45 °C about a centre value of 25°C. Note this compensation is not for the solubility effects. A separate sensor also built into the tip of the sensor achieves this.

19.1.3 Sensor Storage

The Oxygen sensor should be kept moist when not in use to prevent the thin film of electrolyte behind the membrane from drying out. To achieve this, the sensor can be stored with the tip in water or in a humid environment.

For long term storage of several weeks or more, remove the membrane and empty out the electrolyte. Replace the membrane without electrolyte to avoid contamination of the gold and silver surfaces. When the sensor is stored in this way, the membrane should be replaced and the sensor refilled before use.

19.1.4 Maintenance Of The Membrane

The membrane does not require replacement as long as it remains intact. If punctured or suspected of leaking around the edges, it must be replaced. To replace the membrane, please see the separate instruction leaflet supplied with your sensor.

19.1.5 Notes On Units Of Dissolved Oxygen

The terms "Oxygen Concentration" and "Oxygen Partial Pressure" frequently give rise to some confusion.

- Oxygen Concentration is the absolute quantity of oxygen present per unit mass of the liquid.
- Oxygen Partial Pressure is the oxygen fraction of the total pressure of all of the gases present.

For any one liquid system, Oxygen Concentration and Oxygen Partial Pressure are proportional. However, if the solubility of oxygen in the liquid should change owing to increased quantities of solutes, etc., then the ratio of the Concentration to the Partial Pressure must change. Thus, if one saturates distilled water and a 25% solution of Sodium Chloride with air at atmospheric pressure (25°C) both solutions will have almost exactly the same Oxygen Partial Pressure, namely 15.5 cm of mercury. However, the dissolved Oxygen Concentration parts per million (milligrams per litre) will be 8.2 in the distilled water and 2.01 in the salt solution. This is a rather extreme example, as ocean water is only 3.6% saline. It does however stress the importance of correct interpretation of the salinity.

The Clark Sensor measures the partial pressure of oxygen diffusing through a membrane. The current is a linear measure of this partial pressure, assuming sufficient liquid flow conditions.

With air at sea level, the 20.9% oxygen exerts about 15.5 cm of Mercury pressure. Water in equilibrium with air and with no oxygen demand (C.O.D., B.O.D. etc.), is saturated and has this dissolved oxygen partial pressure. If we define 100% Saturation in Partial Pressure terms, then 15.5 cm. Hg = 100% Saturation. This is a practical unit to use. The sensor linear readout is then a linear function of % Saturation. Organic cell walls behave like the sensor and pressure units are valuable.

% Saturation is the best unit for industrial control and not ppM, contrary to popular beliefs. The partial pressure (and consequently the pressure defined % Saturation) varies only slightly with temperature. (Recall at this stage that the permeability of the membrane has a temperature coefficient, but the electronics has scaled this out by the operation of the Automatic Membrane Temperature Compensator Thermistor incorporated in the D.O. sensor).

If mass units are used for measurement of Dissolved Oxygen, the temperature problem of relating the linear partial pressure reading of the sensor to the mass (ppM or mg/L) at different temperatures becomes more involved. As well, there is the mass variation due to dissolved salts (salinity correction). Therefore, the fully corrected instrument would need 3 correction systems.

- (a) Membrane correction for temperature permeability effects ;
- (b) Solubility correction of Dissolved Oxygen with temperature and ;
- (c) Salinity correction of Dissolved Oxygen by weight (Salinity has no effect on pressure units readout).

In the **90-FLMV** instrument,

- (a) Membrane correction is achieved AUTOMATICALLY ;
- (b) To provide the mass units (ppM) readout (so popular due to the Winkler process used in the past), the **90-FLMV** Meter has Solubility Correction via an additional temperature element in the sensor ;
- (c) Salinity correction is performed automatically via the Conductivity sensor.

19.1.6 Equilibrium Conditions

Whilst Saline Water has a lower ppM than does Fresh Water, it does not mean it necessarily has less biologically available oxygen. Both have 100% Saturation (presuming no Chemical Oxygen Demand (C.O.D.), Biological Oxygen Demand (B.O.D.), etc.) because both are in partial pressure equilibrium with air. Any usage of oxygen is immediately replenished by the dissolving of more from air to meet partial pressure equilibrium requirements. This is so for both saline and fresh water. The reporting of oxygen at a lower level (in ppM units) in the Salt Water is therefore **QUITE MISLEADING !**

In closed systems, such as tanks, pipes and deep waters, equilibrium is not so readily available and the Salinity Effect gains the importance in the reporting of Dissolved Oxygen. It is suggested, unless such closed (or deep, low diffusion) systems are encountered, that Oxygen should be reported in % Saturation or ppM of equivalent Fresh Water.

19.1.7 Velocity Past The Membrane

Workers have shown that the relationship between the diffusion current (oxygen current) and the external velocity of the liquid is exponential. Some workers using thicker membranes have shown even less dependence of the diffusion current on liquid velocity. Because of the exponential nature of the relationship, considerable changes in velocity have to be made before noticing any change in the diffusing current once the flow is sufficiently high. Tests with this sensor have shown that flow rates above 0.2 litres/minute past the membrane give results indistinguishable from those with appreciably higher flow rates (5 litres/minute). Fluctuations in readings due to air bubbles passing through the membrane are a different matter, however.

With the type of sensor to be used with this instrument, very little change in diffusion current is caused by altering the pH of the external environment. Pressure changes over a moderate range exerted on the membrane also cause no change. The EDYSI has a pressure compensation diaphragm to allow submersion to 60 metres.

19.2 Conductivity/TDS/Salinity

19.2.1 Care, Cleaning and Maintenance of Conductivity Sensors

Care of Conductivity sensors

The conductivity section of the sensor supplied with your **90-FLMV** consists of two platinum plates that are plated with a layer of “platinum-black”. This is quite a soft layer and is required for stable, accurate measurements. In time, the platinum-black layer may wear off in some applications, at which time the sensor will require replatinising (see detail later in this section). You can help to maintain the platinum-black layer by following these simple rules:

1. **NEVER** touch or rub the sensor plates with your fingers, cloth etc.
2. Avoid using the sensor in solutions that contain a high concentration of suspended solids, such as sand or soil, which can abrade the sensor plates. Filter these types of solutions first if possible.
3. Avoid concentrated acids. If you must measure acids, remove the sensor immediately after taking the measurement and rinse well with distilled water.

Conductivity sensors can be stored dry. Ensure that the sensor is stored in a covered container, to avoid dust and dirt build-up.

Cleaning of Conductivity Sensors.

Platinised platinum Conductivity sensors can only be cleaned by rinsing in a suitable solvent.

DO NOT wipe the sensor plates, as this will remove the platinum-black layer.

1. Rinsing in distilled water will remove most build-ups of material on the sensor plates.
2. Films of oils or fats on the sensor plates can usually be removed by rinsing the sensor in methylated spirits.
3. Stubborn contamination can be removed by soaking the sensor in a solution of 1 part Concentrated HCl and 10 parts distilled water. The sensor should not be soaked for more than approximately 5 minutes, otherwise the platinum-black layer may start to dissolve.
4. If all of these methods fail, then the last resort is to physically scrub the sensor plates, which will remove the contaminant and the layer of platinum-black. Use only a cloth or nylon scouring pad. **DO NOT USE STEEL WOOL**. The sensor will then need to be cleaned in HCl, as per step 3 and replatinised (see detail later in this section).

Replatinising Conductivity Sensors

There are several ways to replatinise Conductivity sensors.

1. The simplest way is to return the sensor to the TPS factory. We can fully clean the sensor, replatinise it and test all aspects of its performance.
2. An automatic replatiniser is available from TPS, along with replatinising solution. This will plate the sensors for the right amount of time at the correct current. Ordering details are as follows...

Automatic Conductivity Sensor Replatiniser	Part No 122160
20mL Platinising Solution (suitable for approx 30 uses)	Part No 122300

3. Conductivity sensors can be manually replatinised, according to the following procedure...
 - (a) Soak the sensor in a solution of 1 part Concentrated HCl and 10 parts distilled water for approximately 5 minutes.
 - (b) Rinse the sensor well in distilled water.
 - (c) Immerse the sensor in platinising solution at least to the vent hole in the body. Platinising solution is available from TPS (part no 122300). Alternatively, platinising solution can be prepared by dissolving 1g of Hydrogen Chloroplatinate (H_2PtCl_6) in 30mL of distilled water, and including about 0.01g of Lead Acetate ($(\text{CH}_3\text{COO})_2\text{Pb}$) and a drop or two of concentrated HCl. **Caution : This is a dangerous solution and should be handled with the utmost care.**
 - (d) Apply a direct current of 10mA between pins 7 and 8 of the sensor plug, as per the diagram below. Reverse the polarity every 30 seconds. After approximately 8 minutes (4 minutes per sensor plate), they should have an even “sooty” appearance. Avoid excess current as this will cause incorrect platinising.
 - (e) After platinising, rinse the sensor well in distilled water.
 - (f) If you have any doubts about any of these steps, then you should consider returning the sensor to the factory. The cost of replatinising is quite low, and you will be guaranteed of the best possible result.

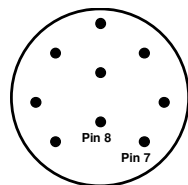

Sensor Connector

19.3 pH

pH sensors are generally combination sensors, where the pH sensing membrane and the reference system are contained in a single body. The sensing membrane is the round or spear shaped bulb at the tip of the sensor. This produces a voltage that changes with the pH of the Solution. This voltage is measured with respect to the reference section. The reference section makes contact with the sample solution using a salt bridge, which is referred to as the reference junction. A saturated solution of KCl is used to make contact with the sample. It is vital that the KCl solution has an adequate flow rate in order to obtain stable, accurate pH measurements.

19.3.1 Asymmetry of a pH or Specific Sensor

An “ideal” pH sensor produces 0 mV output at 7.00 pH. In practice, pH sensors generally produce 0 mV output at slightly above or below 7.00 pH. The amount of variance from 7.00 pH is called the asymmetry.

Figure 19-1 illustrates how asymmetry is expressed for a pH sensor.

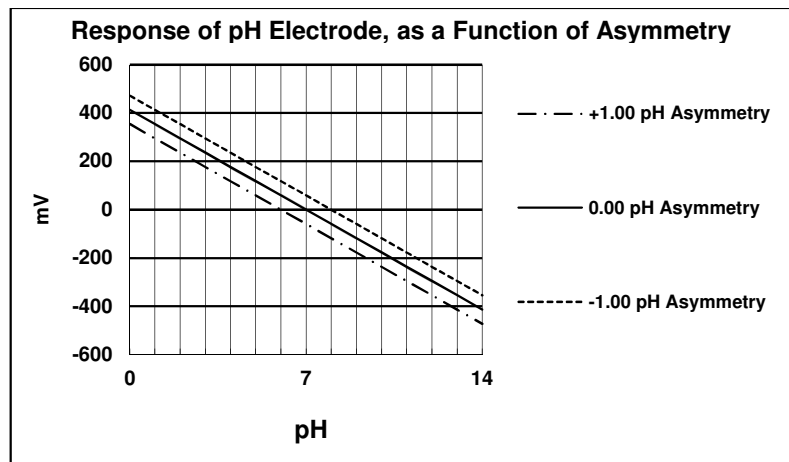

Figure 19-1

19.3.2 Slope of a pH Sensor

As mentioned above, a pH sensor produces 0 mV output at around 7.00 pH. As the pH goes up, an “ideal” pH sensor produces -59.16mV/pH unit at 25°C . As the pH goes down, an ideal pH sensor produces $+59.16\text{mV/pH}$ unit. In practice, pH sensors usually produce slightly less than this. The output of a pH sensor is expressed as a percentage of an ideal sensor. For example, an ideal sensor that produces 59.16mV/pH unit has “100% Slope”. An sensor that produces 50.15mV/pH unit has “85% Slope”.

Figure 19-2 illustrates the principle of sensor slope, using a pH sensor as an example.

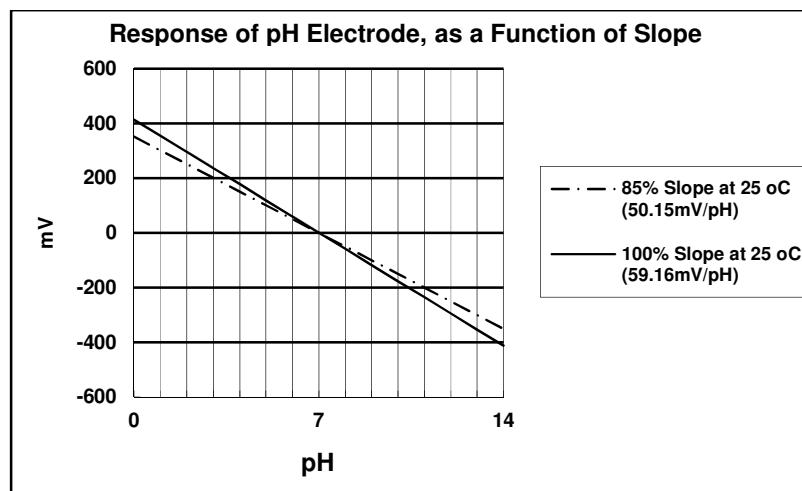

Figure 19-2

19.3.3 Temperature Compensation

The slope of a pH sensor is affected by temperature. This effect is compensated for either by using an Automatic Temperature Compensation (ATC) sensor. Figure 19-3 shows the slope of a pH sensor at various temperatures.

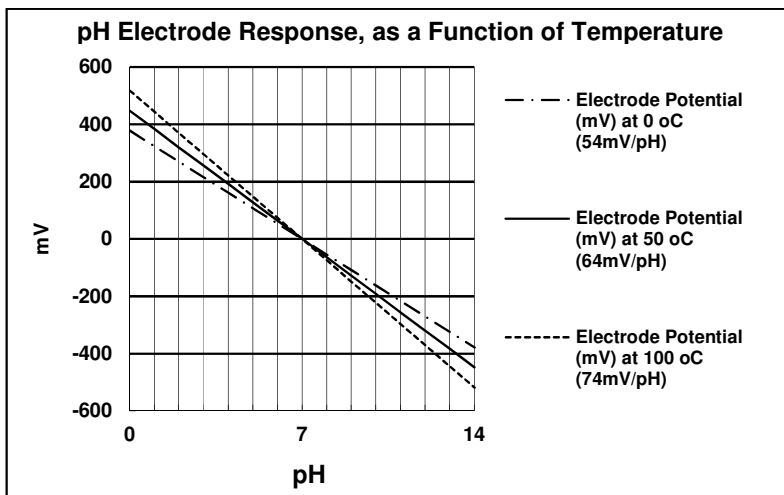

Figure 19-3

20. Warranty

TPS Pty Ltd guarantees all instruments and sensors to be free from defects in material and workmanship when subjected to normal use and service. This guarantee is expressly limited to the servicing and/or adjustment of an instrument returned to the TPS Pty Ltd Factory Service Centre, freight prepaid, within twelve (12) months from the date of delivery, and to the repairing, replacing, or adjusting of parts which upon inspection are found to be defective. Warranty period on sensors is six (6) months.

Freight costs to and from the factory are the responsibility of the purchaser. Shipping damage is not covered by this warranty.

TPS Pty Ltd accepts no liability for any incidental or consequential damages caused by or resulting from the use or misuse of this equipment either due to failure of the equipment, incorrect calibration, incorrect operation, or from interpretation of information derived from the equipment. Specifications are subject to change without notice. This warranty becomes invalid if modifications or repairs are carried out on this unit by unauthorised persons. There are no express or implied warranties which extend beyond the face hereof.

Procedure for Service

Please read service details on our '**Service**' web page first:

<http://www.tps.com.au/service.htm>

TPS Pty Ltd has a reputation for prompt and efficient service. If you feel that this equipment is in need of repair, please re-read the manual. Sometimes, instruments are received for "repair" in perfect working order. This can occur where batteries simply require replacement or re-charging, or where the sensor simply requires cleaning or replacement.

Return the instrument AND ALL SENSORS to TPS Pty Ltd freight pre-paid. It is your responsibility as the sender to ensure that TPS Pty Ltd receives the unit, so consider using a traceable freight service.

Please check that the following is enclosed with your equipment:

- **A TPS 'Service / Return Goods Form' – see web link below:**
http://www.tps.com.au/Service/Service%20form_web.pdf
- **Your full name**
- **Your company name**
- **Your email address or fax number**
- **Your return street address**
- **A description of the fault. (Please be specific - "Please Repair" does not describe a fault.)**

Your equipment will be repaired and returned to you by express air freight where possible.

For instruments beyond warranty period, a repair cost will be calculated from parts and labour costs and emailed to you. If you decline to have the equipment repaired, the complete instrument will be returned to you freight paid, not serviced.

TPS Pty Ltd has only one service location, which is located at our factory in Brisbane:

Service Department

TPS Pty Ltd

Unit 6 / 253 Leitchs Road

Brendale, QLD 4500

Australia

T: (07) 3205 8027

F: (07) 3808 4871

E: tps@tps.com.au

W: www.tps.com.au